

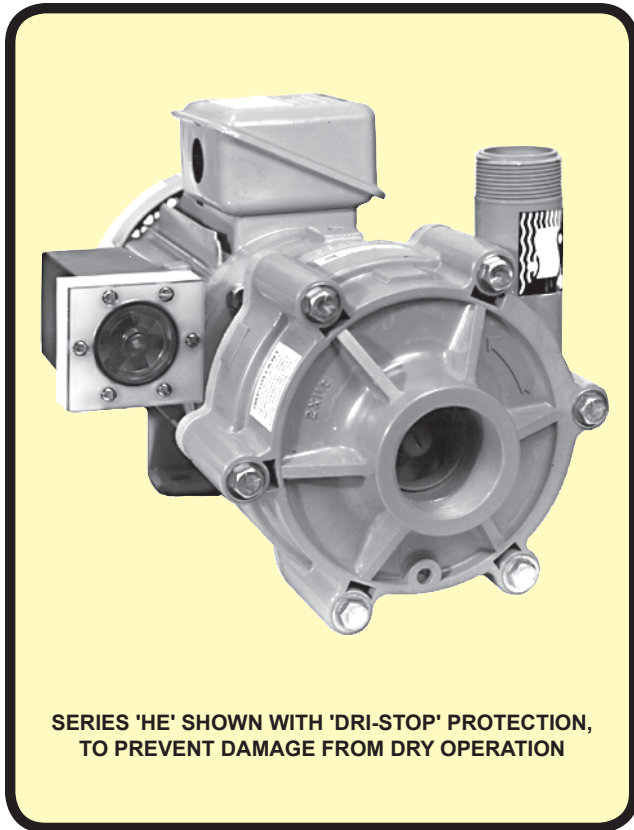

SERFILCO®

SERIES 'HE' HORIZONTAL PUMPS

BULLETIN
P-201_T
AUG 2010



SERIES 'HE' SHOWN WITH 'DRI-STOP' PROTECTION,
TO PREVENT DAMAGE FROM DRY OPERATION

ENERGY SAVING CENTRIFUGAL PUMPS FOR:

**ACID / AQUEOUS / CAUSTIC
CHEMICAL / ETCHING / PHOTOGRAPHIC
PLATING / SCRUBBING / WASTES**

- **Flows to 175 U.S. GPM or 130 ft. TDH @ 60 Hz**
(552 LPM or 28 M @ 50 Hz)
- **Non-metallic solution contact**
High temperature polypropylene, CPVC, PVDF or ECTFE (*Refer to a chemical resistance chart*)
- **Single or double mechanical seal,**
carbon/ceramic, or silicon carbide with EPDM or Viton® elastomers
- **Centrifugal - quiet, vibration-free**
- **NPT or metric connections available**
- **Pump casing indexes to six directions of discharge**
- **Chemical duty motor (1.0 - 7.5 HP)**
Sealed oversized bearings, liquid/vapor seal and slinger, cast iron end bells, corrosion resistant two-part epoxy finish, stainless steel nameplate, 1.15 service factor at 50 or 60 Hz.

Here is a pump capable of "total" chemical resistance, both internally and externally with its non-metallic construction of all wetted components, choice of seal assembly and elastomer materials. The use of engineered plastics in a choice of materials provide excellent chemical compatibility for the most demanding applications.

The totally enclosed impeller is molded to close tolerances which allow this pump to operate at peak horsepower efficiency across a broad range of operational flow/head requirements

The external mechanical seal and impeller sleeve design isolates metal components to provide non-metallic solution contact with the pumped solution. The standard (M8) seal assembly has silicon carbide seal faces and is the most durable and longest lasting mechanical seal available. The double mechanical seal models require water lubrication of the seal faces and allows the pump to be used for solutions containing abrasives, high salt concentrations and for electroless plating solutions. Either Viton or EPDM elastomers are available on the 'HE' pump.

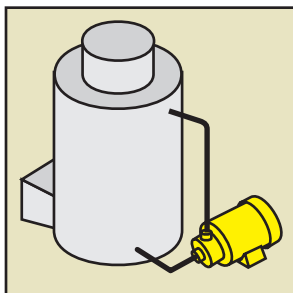

PRESSURE
SPRAYING

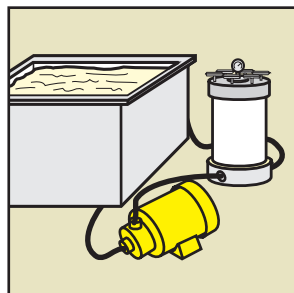

FILTER
SYSTEM

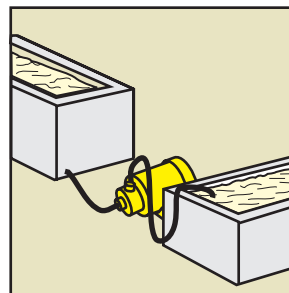

WASTE
TREATMENT

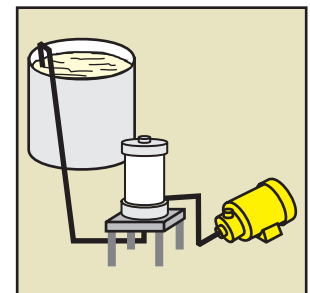

SOLUTION TRANSFER
w/PRIMING CHAMBER

SERIES 'HE' Specifications and Performance Curves

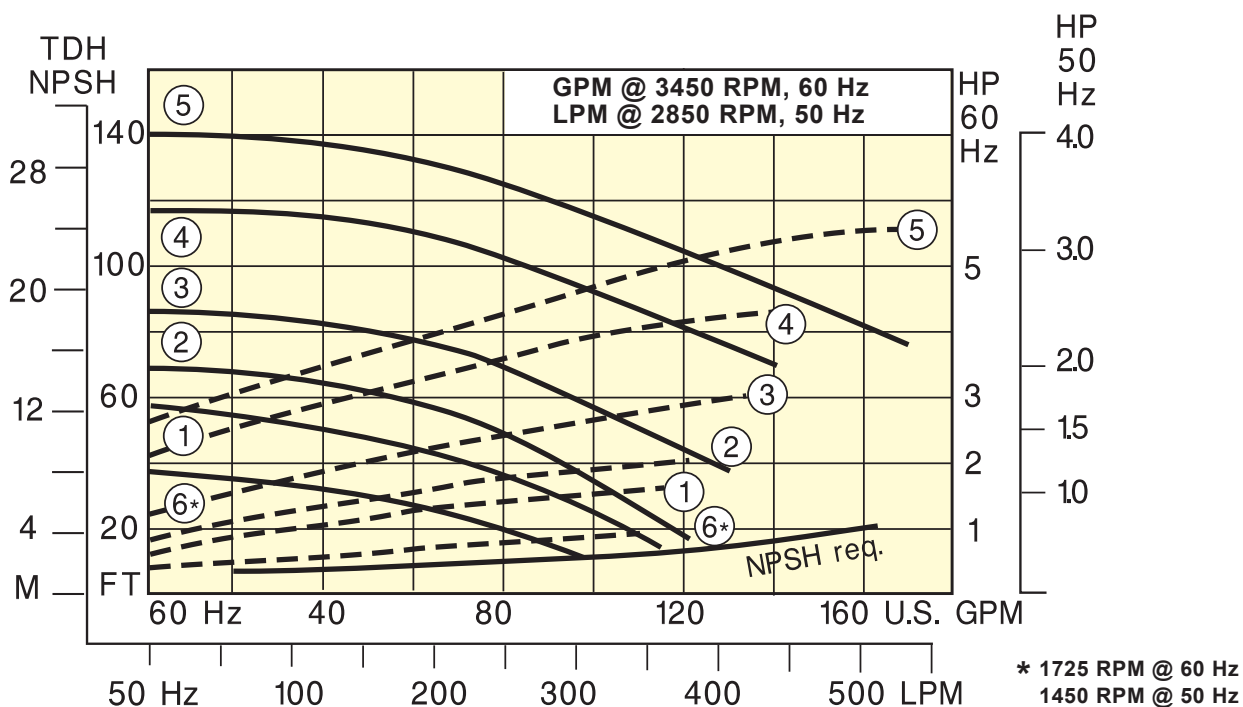

DIMENSIONS in inches (mm)

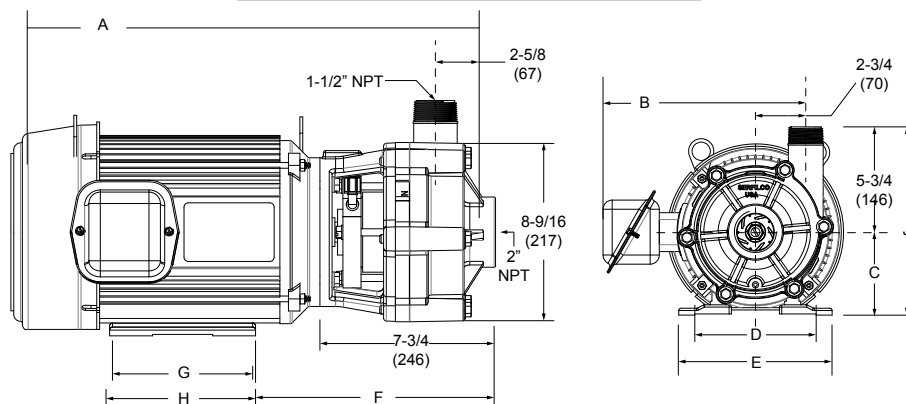

DIMENSIONS for NEMA motors are in inches and those for metric motors are in mm.

											MOTOR WT.*
											Lbs.
NEMA	MOTOR HP	A	B	C	D	E	F	G	H	J	Lbs.
	1.5 (& 1 @ 1725 RPM)	16.94	8.63	3.5	5.5	6.75	10.5	4	4.75	9.25	43
	2 (& 1.5 @ 1725 RPM)	18	8.63	3.5	5.5	6.75	10.5	5	5.75	9.25	44
	3	19.63	9.63	4.5	7.5	9	11.25	4.5	5.5	10.25	50
	5	21	9.63	4.5	7.5	9	11.25	5.5	6.5	10.25	65
7.5	21	9.63	4.5	7.5	9	11.25	5.5	6.5	10.25	110	
METRIC	MOTOR KW	A	B	C	D	E	F	G	H	J	Kg.
	1.5 (90S frame)	496	212	90	140	170	307	100	125	236	23
	2.2 (90L frame)	521	212	90	140	170	307	125	150	236	25
3.0 (100 frame)	549	236	100	160	197	314	140	172	246	30	

*For shipping weight, add 15 lbs (6.8 Kg.) to motor weight.

SERIES 'HE' Specifications and Ordering Information

Standard models are constructed of CPVC, polypropylene, PVDF, or ECTFE with threaded connections. The motor shaft is protected by the impeller sleeve assembly. Elastomers are EPDM or Viton. Impellers are enclosed. The mechanical seal is type 21, externally mounted with stainless steel components not in solution contact. A double mechanical seal is recommended for solutions

containing abrasives and for high temperature or other critical service. Close coupled motors are NEMA 'JM' or metric (IEC) standard. The motors designated NEMA can operate on 50 or 60 Hz at full rated horsepower. Consult Application Engineering Department for BSP fittings or adapters.

ORDERING INFORMATION

*For standard CPVC, PP, PVDF, and ECTFE pump-motor combination, select model from TABLE I.
For other pump-motor combinations, select from TABLE II.*

TABLE I STANDARD MODELS

Select flow curve number providing the desired performance. Then match to Model Number listed below. Standard models include silicon carbide single mechanical seal with EPDM or Viton elastomers. Motor HP is non-overloading at full capacity with 1.1 specific gravity fluids.

FLOW CURVE NO.	CPVC/EPDM	PRICE CODE NUMBER	POLYPROPYLENE**/EPDM	PRICE CODE NUMBER
	MODEL NO.		MODEL NO.	
1	H2 x 1½ CE1L(M8) -D1.5	42-0110A	H2 x 1½ PE1L(M8) -D1.5	42-0410A
2	H2 x 1½ CE2L(M8) -D2.0	42-0120B	H2 x 1½ PE2L(M8) -D2.0	42-0420B
3	H2 x 1½ CE3L(M8) -D3.0	42-0130C	H2 x 1½ PE3L(M8) -D3.0	42-0430C
4	H2 x 1½ CE4L(M8) -D5.0	42-0140D	H2 x 1½ PE4L(M8) -D5.0	42-0440D
5	H2 x 1½ CE5L(M8) -D7.5	42-0150E	H2 x 1½ PE5L(M8) -D7.5	42-0450E
6	H2 x 1½ CE6L(M8) -H1.0	42-0160F	H2 x 1½ PE6L(M8) -H1.0	42-0460F

FLOW CURVE NO.	PVDF/Viton	PRICE CODE NUMBER	ECTFE/EPDM	PRICE CODE NUMBER
	MODEL NO.		MODEL NO.	
1	H2 x 1½ KE1V(M8) -D1.5	42-0318A	H2 x 1½ HE1L(M8) -D1.5	42-0610A
2	H2 x 1½ KE2V(M8) -D2.0	42-0328B	H2 x 1½ HE2L(M8) -D2.0	42-0620B
3	H2 x 1½ KE3V(M8) -D3.0	42-0338C	H2 x 1½ HE3L(M8) -D3.0	42-0630C
4	H2 x 1½ KE4V(M8) -D5.0	42-0348D	H2 x 1½ HE4L(M8) -D5.0	42-0640D
5	H2 x 1½ KE5V(M8) -D7.5	42-0358E	H2 x 1½ HE5L(M8) -D7.5	42-0650E
6	H2 x 1½ KE6V(M8) -H1.0	42-0368F	H2 x 1½ HE6L(M8) -H1.0	42-0660F

** Polypropylene models are glass reinforced

