



DB11/15 SERIES

ASSEMBLY, INSTALLATION

AND OPERATION MANUAL

P/N 107403 R20

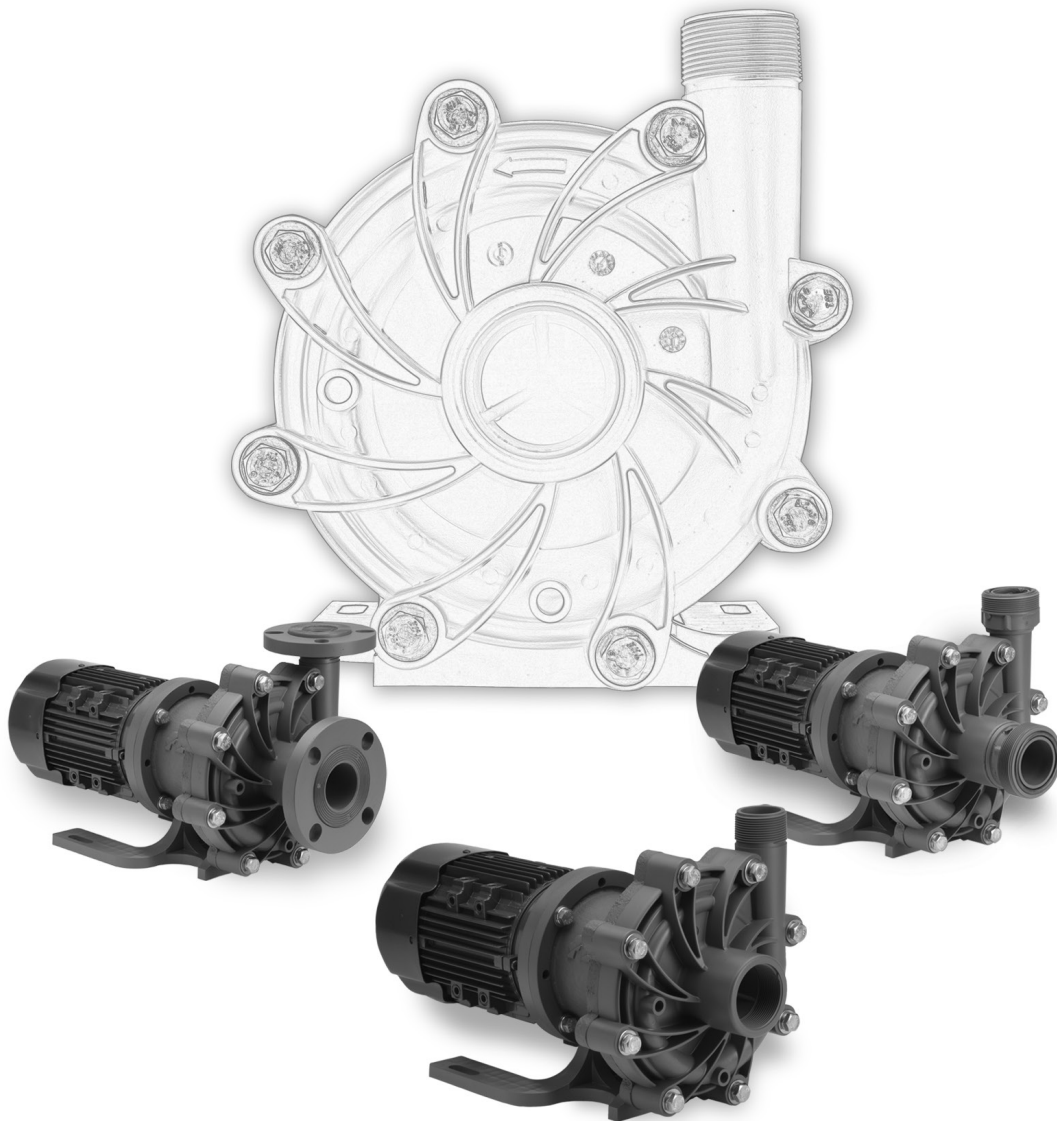



FINISH THOMPSON INC.

921 Greengarden Road • Erie, PA 16501-1591 U.S.A.
Ph 814-455-4478 • Fax 814-455-8518
Email fti@finishthompson.com • www.finishthompson.com

EU Declaration of Conformity



Finish Thompson Inc. hereby declares that the following machine(s) fully comply with the applicable health and safety requirements as specified by the EU Directives listed. The product may not be taken into service until it has been established that the drive motor for the centrifugal pump complies with the provisions of all relevant EU Directives. The complete product complies with the provisions of the EC Directive on machinery safety provided motors carry CE marking.

This declaration is valid provided that the devices are fully assembled and no modifications are made to these devices.

Type of Device:
Centrifugal Pumps

Models:

AC/AK/AV - 400/500/600/800	GP-11/22/32	VKC-5.5/6/6H/7/8/10
DB-3/4/5/5.5/6/6H/7/8/9/10/11/15/22	MSKC	SP-10/11/15/22
KC-3/4/5/5.5/6/6H/8/10/11/22/32	MSVKC	
UC-1516/1516L/1518/1518L/2110/3158/326/326H/328/436/438/4310H/326H/4310H/6410		

EU Directives:
Machinery Safety (2006/42/EC)

Applied Harmonized Standards:
EN ISO 12100
EN 809

Manufacturer: Finish
Thompson Inc.
921 Greengarden Road
Erie, Pennsylvania 16501-1591 U.S.A

Signed,

President

1 August 2016

Person(s) Authorized to Compile Technical File: Finish Thompson GmbH
Otto-Hahn-Strasse 16
Maintal, D-63477 DEU
Telephone: 49 (0)6181-90878-0

EU Declaration of Conformity

Manufactured by:

Finish Thompson, Inc.
921 Greengarden Road
Erie, Pennsylvania 16501 U.S.A.
Phone: 1-(814)-455-4478
Fax 1-(814)-455-8518
Email: fti@finishthompson.com
Web: www.finishthompson.com



II 2GD
Ex h IIC T6...T4 Gb
Ex h IIIC T6...T4 Db

FTZU 06 ATEX A136-06 FTZU 08 ATEX A174-08
FTZU 07 ATEX A166-07

Finish Thompson declares under our sole responsibility that the product listed below conforms to the relevant provisions of EU directive **2014/34/EU of 26 February 2014** for equipment and protective systems intended for use in potentially explosive atmospheres, and is certified for safe use in **Atmosphere Group IIC/IIIC category 2** areas.

This declaration applies to Finish Thompson, Inc **ATEX DB Series** pumps only manufactured out of carbon fiber filled PVDF with a conductive motor adapter and non-sparking ring designated by the letter "V" and "A" in the model number. Pumps and their model number may also contain many different combinations of bushings, shafts, o-rings, port connections, impellers, magnet sets, motor adapters and other options.

Models: DB6V-A, DB6HV-A, DB7V-A, DB8V-A, DB9V-A, DB10V-A, DB11V-A, DB15V-A & DB22V-A.

This product has used the following harmonized standards to verify conformance:

Non-electrical equipment for potentially explosive atmospheres: **EN ISO 80079-36:2016**
Basic Methods and Requirements.

Non-electrical equipment intended for use in potentially explosive atmospheres: **EN ISO 80079-37:2016**
Protection by construction safety "ch." and control of ignition source "bh"

This product must not be used in areas other than specified above. If in doubt consult an authorized distributor, or refer to the manufacturer Finish Thompson.

Approved by:

Date: 5/5/2017

TABLE OF CONTENTS

Description	Page Number
Important Information.....	5
Chemical Reaction Disclaimer.....	5
Safety Precautions	5
Installation/Operation Precautions	6
ATEX Safety Precautions	6-7
DB11/15 Capabilities.....	7
DB11/15 OIM Section I - Assembly.....	8
DB11/15 OIM Section II - Installation.....	9
DB11/15 OIM Section III - Start-up and Operation.....	10
DB11/15 OIM Section IV - Maintenance.....	10
DB11/15 OIM Section V - Disassembly.....	11-13
DB11/15 OIM Section VI - Reassembly.....	13-14
Part Number Explanation	15
DB11/15 OIM Exploded View - Parts Drawing.....	16
DB11/15 OIM Parts Table.....	17-20
DB11/15 OIM Section VII - Troubleshooting	21
DB11/15 OIM Section VIII - Warranty	21

IMPORTANT INFORMATION - READ ME FIRST!

Model Number and Serial Number

Record the model number and serial number below for future reference. This is important information when ordering replacement parts or when technical assistance is required. The numbers are found on a label located on the motor adapter.

MODEL NUMBER = _____

SERIAL NUMBER = _____

IMPORTANT NOTICE

U.S. Export Administration Regulations, pursuant to ECCN 2B350, prohibit the export or reexport to certain enumerated countries of sealless centrifugal pumps in which all wetted materials are constructed from fluoropolymers without first applying for and obtaining a license from the U.S. Bureau of Industry and Security (BIS). This affects all Finish Thompson magnetic-drive pumps constructed from PVDF or lined with ETFE. Please contact the BIS (www.bis.doc.gov) or Finish Thompson with questions regarding the Regulations or a list of the countries to which they apply.

Chemical Reaction Disclaimer

The user must exercise primary responsibility in selecting the product's materials of construction, which are compatible with the fluid(s) that come(s) in contact with the product. The user may consult Finish Thompson, Inc. (manufacturer) and a manufacturer's representative/distributor agent to seek a recommendation of the product's material of construction that offers the optimum available chemical compatibility.

However neither manufacturer nor agent shall be liable for product damage or failure, injuries, or any other damage or loss arising out of a reaction, interaction or any chemical effect that occurs between the materials of the product's construction and fluids that come into contact with the product's components.

Safety Precautions

! WARNING: READ THIS MANUAL COMPLETELY BEFORE INSTALLING AND OPERATING THIS UNIT. FAILURE TO FOLLOW THESE PRECAUTIONS CAN RESULT IN SERIOUS INJURY OR DEATH.

! WARNING: Magnetic field hazard: This pump contains powerful magnets. Exposed magnets (pump not connected to motor) produce powerful magnetic fields. Individuals with cardiac pacemakers, implanted defibrillators, other electronic medical devices, metallic prosthetic heart valves, internal wound clips (from surgery), metallic prosthetic devices or sickle cell anemia must not handle or be in the proximity of the magnets contained inside the pump. Consult a health care provider for specific recommendations before working with this pump.

! WARNING: Magnetic force hazard. This pump should only be disassembled and assembled using the recommended procedures. The magnetic attraction is powerful enough to rapidly pull the motor end and the wet end together. Do not place fingers between the mating surfaces of the motor and wet ends to avoid injuries. Keep the drive magnet and impeller assembly away from metal chips or particles, items with magnetic stripes like credit cards and magnetic computer media such as floppy discs and hard drives.

! WARNING: When pumping flammable or combustible liquids with a DB Series pump it is important to follow these guidelines:

1. You must use a PVDF pump. PVDF has conductive carbon fibers added which allow it to be grounded when installed in a properly grounded piping system or when a properly installed grounding strap is attached to a housing bolt. If PVDF is not compatible with the liquid being pumped, you should consider an ETFE lined UC Series magnetic drive pump.
2. You must select the non-sparking (Ns) bronze bump ring option. The non-sparking ring is pressed into the clamp ring or motor adapter and prevents sparking should the motor bearings fail and the outer mag drive assembly runs out of round.
3. You must select an explosion-proof FTI motor or provide your own explosion-proof motor.

When pumping non-flammable or non-combustible liquids in a hazardous area using a DB Series pump, it is important to take these guidelines:

1. You must select the non-sparking (Ns) bronze bump ring option. The non-sparking ring is pressed into the clamp ring or motor adapter and prevents sparking should the motor bearings fail and the outer mag drive assembly runs out of round.

2. You must select an explosion-proof FTI motor or provide your own explosion-proof motor.

⚠ WARNING: Hot surfaces. This pump is capable of handling liquids with temperatures as high as 220° F (104° C). This may cause the outer areas of the pump to become hot as well and could cause burns.

⚠ WARNING: Rotating Parts. This pump has components that rotate while in operation. Follow local safety standards for locking out the motor from the power supply during maintenance or service.

⚠ WARNING: Chemical Hazard. This pump is used for transferring many types of potentially dangerous chemicals. Always wear protective clothing, eye protection and follow standard safety procedures when handling corrosive or personally harmful materials. Proper procedures should be followed for draining and decontaminating the pump before disassembly and inspection of the pump. There may be small quantities of chemicals present during inspection.

⚠ WARNING: The pump and associated components are heavy. Failure to properly support the pump during lifting and movement could result in serious injury or damage to the pump and components.

⚠ WARNING: Never run pump at less than minimum flow or with the discharge valve closed. This could lead to pump failure.

Installation/Operation Precautions

⚠ CAUTION: This pump should never be operated without liquid in the casing. It is recommended that run dry protection be used. Optional electronic power monitors are available to help protect against run dry. If the pump has a PTFE, ceramic or silicon carbide bushing, IT CANNOT BE RUN DRY WITHOUT CAUSING DAMAGE TO THE PUMP. However, the pump can operate without liquid in the casing if the pump has a carbon bushing. The exact length of time the pump can operate dry with a carbon bushing varies with operating conditions and the environment.

⚠ CAUTION: Never start or operate with a closed suction valve. Never operate with a closed discharge valve.

⚠ CAUTION: Always provide adequate NPSHa (net positive suction head available). It is recommended to provide at least 2 feet (61 cm) above the NPSHr (net positive suction head required).

⚠ CAUTION: If pump is used on variable speed drive, do not exceed the frequency for which the pump was designed (for example, if the pump is a 50 Hz model, do not exceed 50 Hz).

ADDITIONAL SAFETY PRECAUTIONS FOR ATEX COMPLIANT PUMPS

DB Series:

The pump is designed for   1026 **II 2GD**
Ex h IIC T6...T4 Gb
Ex h IIIC T6...T4 Db

⚠ Protection Control

A power monitor, flow switch, pressure switch or similar device must be used to protect against dry running, closed discharge valve or decoupling. Any of these conditions could lead to a rise in surface temperature of the pump.

⚠ Construction Materials

Pump must be manufactured from PVDF with a PVDF motor adapter and bronze bump ring and have the designation “-A” in the pump part number. The PVDF contains conductive carbon which allows it to be grounded when installed in a properly grounded piping system or when a properly installed grounding strap is attached to a housing bolt. The bronze bump ring is pressed into the clamp ring or motor adapter and prevents sparking should the motor bearings fail and the outer drive magnet runs out of round.

⚠ Grounding

Static sparking can cause an explosion. When operating in a hazardous area or pumping a hazardous fluid the entire pump system must be grounded to prevent static discharge. Before operating the pump, ensure the electrical continuity throughout the pumping system and earth ground is 1 Ohm or less. If greater than 1 Ohm, re-check all grounding connections.

⚠ Elastomer Selection

Proper o-ring material must be chosen for the fluid being pumped. Improper material selection could lead to swelling and be a possible source of leaks. This is the responsibility of the end user.

⚠ Leaks

The pump must be checked for leaks on a regular basis. If leaks are noticed, the pump must be repaired or replaced immediately.

Temperature Classification

The surface temperature of the DB Series pumps depends upon the temperature of the fluid that is being pumped. The following chart lists different fluid temperatures and the corresponding pump surface temperature.

Fluid Temperature	Maximum Surface Temperature	Temperature Class	Maximum Allowable Surface Temperature
21°C (70°F)	55°C (131°F)	T6	85°C
77°C (170°F)	76°C (168°F)	T5	100°C
104°C (220°F)	84°C (183°F)	T4	135°C

Cleaning

The pump must be cleaned on a regular basis to avoid dust build up greater than 5 mm.

Motor Rotation Test

Pump must be full of liquid with no trapped air in the suction and discharge lines before the rotation of the motor is checked. Do not operate pump until it is full of liquid.

Start up

The pump must be filled from a flooded suction tank (gravity) or primed with liquid from an outside source. Open the inlet (suction) and discharge valves completely and allow the pump to fill with liquid. Close the discharge valve. Turn the pump on and slowly open the discharge valve. Adjust the flow rate and pressure by regulating the discharge valve. Do not attempt to adjust the flow with the suction valve.

Maintenance

The recommended maintenance schedule depends upon the nature of the fluid being pumped and the specific application. If the pump is used on a clean fluid, it is recommended that the pump be removed from service and examined after six months of operation or after 2,000 hours of operation. If the pump is used on fluids with solids, high temperatures or other items that could cause accelerated wear, then this initial examination should be sooner.

After the initial examination of the internal components and wear items are measured, a specific maintenance schedule can be determined. For best results, it is recommended that the pump be removed from service annually for examination.

DB11/15 Capabilities

Maximum Working Pressure: 90 psi (6.2 bar) (models with o-ring)
Maximum Viscosity: 150 cP
Maximum Temperature: Polypropylene -180° F (82° C); PVDF – 220° F (104° C)
Note: Maximum temperature is application dependent.
Consult a chemical resistance guide or the chemical manufacturer for chemical compatibility and temperature limits.

Maximum Noise Level: 78 dBA (pump only)

Solids: Maximum particle size is 100 microns for slurries and 1/64" (.4 mm) for infrequent particles. Maximum hardness is 80 HS. Maximum concentration is 10% by weight. If solids are being pumped, it is recommended that the pump have either ceramic or for best results, silicon carbide components. Pumping solids may lead to increased wear.

Minimum Allowable Flow Rate:

Do not allow the flow rate to drop below the minimum flow rate listed in the chart below:

Model	3450 rpm	1725 rpm	2900 rpm	1450 rpm
DB11	4 gpm (.9 m ³ /hr)	2 gpm (.5 m ³ /hr)	.76 m ³ /hr (3.4 gpm)	.38 m ³ /hr (1.7 gpm)
DB15	5 gpm (1.1 m ³ /hr)	2.5 gpm (.6 m ³ /hr)	.95 m ³ /hr (4.2 gpm)	.48 m ³ /hr (2 gpm)

Maximum Allowable Motor Power:

Do not exceed the maximum power rating for the pump coupling.

Standard coupling for the DB11 is 6-pole; standard coupling for the DB15 is 8-pole.

6-pole coupling	=	2 horsepower (1.5 kW)
8-pole coupling	=	3 horsepower (2.2 kW)
10-pole coupling	=	5 horsepower (4 kW)

DB11/15 ASSEMBLY, INSTALLATION & OPERATION

Unpacking and Inspection

Unpack the pump and examine for any signs of shipping damage. If damage is detected, save the packaging and notify the carrier immediately.

Section I - Assembly

Pumps with Motors

Proceed to "Installation" Section.

Pumps Without Motors

NOTE: 184TC and 100/112 frame motors must have feet.

Tools Required - Metric socket or wrench set, 9/16" socket or wrench and 3/16" Allen bit & torque wrench (NEMA motors only).

The NEMA 182-184TC and IEC 80, 90, 100/112 B14 flange models will require a 1/4" drive ratcheted and 9/16" socket to install (items 22, 23, 24) motor adapter bolt, lock washer, and flat washer between the foot.

1. Remove the pump, drive magnet assembly and hardware package from the carton. Do not remove the shipping plug until after the pump has been installed on the motor.

CAUTION: Keep away from metallic particles, tools, and electronics. Drive magnets MUST be free of metal chips.

WARNING: Keep the drive magnet away from the open end of the motor adapter and barrier. Strong magnetic attraction could allow the drive hub to enter the motor adapter resulting in injury or damage.

2. Place motor on the fan end. For 56C/145TC and B5 frame motors go to step 4. See figure 1.
3. For 184 NEMA and IEC motors only - install the motor adapter flange (item 10) on the motor face using bolts, lock washers and flat washers (items 21, 22, 23). See figure 2.



Figure 1



Figure 2

Torque bolts to the following:

- 80 frame (M6) = 90 in-lb (10.2 N-m)
- 90/100/112 frame (M8) = 130 in-lb (14.4 N-m)
- 184 NEMA (1/2") = 300 in-lb (33.9 N-m)

Note: Apply anti-seize compound on threads of the bolts.

4. Coat the motor shaft with anti-seize compound. Insert key supplied with motor into keyway on motor shaft. See figure 3.



Figure 3

NOTE: Make sure the motor shaft is clean and free of burrs. The outer drive is precision machined and has a bore tolerance of +.0005/-0 inch.

5. Slide the outer drive magnet assembly (item 9) onto the motor shaft until the motor shaft contacts the snap ring in the bore of the drive. Figures 4 and 5.



Figure 4



Figure 5

6. Secure the drive on the motor shaft.

WARNING: Be careful, magnets will try to attract tools.

Metric Motors: Secure the drive to the motor shaft using bolt, lock washer and flat washer (items 18, 19, 20). Thread the bolt into the end of the motor shaft (while holding the outer drive to prevent it from turning). See figure 6.

Tighten the bolt to the following:

- 80 frame (M6) = 90 in-lb (10.2 N-m)
- 90 frame (M8) = 130 in-lb (14.7 N-m)
- 100/112 frame (M10) = 240 in-lb (27.1 N-m)

NEMA Motors: Install set screws (item 9A) into threaded holes on the side of the outer drive magnet assembly. Using a 3/16" Allen bit & torque wrench, tighten to 228 in-lbs. (25.8 N-m). See figure 7.

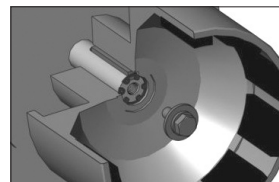

Figure 6 - IEC Drive

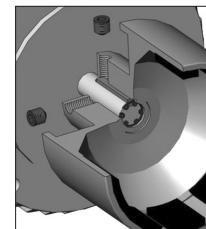

Figure 7 - NEMA Drive

7. For NEMA 56C and 145TC frame motors:

Install o-ring (item 8E) in the groove on the back of the motor adapter (item 8D). Use petroleum jelly to hold the o-ring in place during installation. Note: 184TC and metric adapters do not use this o-ring. Install the pump end on the motor/drive magnet assembly. With the motor facing upright, align the pump feet so that the motor feet and pump feet are on the same side.

Tip the pump end at an angle (discharge is approximately 45°) so that it is just touching the edge of the outer drive magnet assembly. See figure 8.

Carefully lower the pump onto the drive magnet assembly by tipping discharge forward to 90° and dropping straight down. The last 3-4 inches (8-10 cm) before the pump reaches the motor will have STRONG magnetic attraction between the pump and outer drive magnet assembly.



Figure 8

8. Secure the pump to the motor with (4) 3/8" bolts, lock washers and flat washers (items 15,16,17). See figures 9 and 10.

NOTE: Apply anti-seize compound on threads of bolts.



Figure 9



Figure 10

NOTE: B5 flange motors will require customer supplied hardware. B5 pumps with 100/112 frame do not include a pump foot.

9. Rotate the motor fan to ensure there is no binding in the pump.
10. Proceed to Installation Section

Piping



CAUTION: The NPSH available to the pump must be greater than the NPSH required. Filters, strainers and any other fittings in the suction line will lower the NPSH available and should be calculated into the application.

- Install the pump as close to the suction source as possible.
 - Support the piping independently near the pump to eliminate any strain on the pump casing. Also, the piping should be aligned to avoid placing stress on the pump casing.
 - The suction side of the pump should be as straight and short as possible to minimize pipe friction.
 - Keep bends and valves at least ten pipe diameters away from the suction and discharge.
 - The suction line should be at least as large as the suction inlet port or one pipe size larger so that it does not affect the NPSHa. Do not reduce the suction line size.
 - The suction line should not have any high spots. This can create air pockets. The suction piping should be level or slope slightly upward to the pump.
 - A check valve and control valve (if used) should be installed on the discharge line. The control valve is used for regulating flow. An isolation valves on the suction and discharge are used to make the pump accessible for maintenance. The check valve helps prevent the pump against damage from water hammer. This is particularly important when the static discharge head is high.
 - If flexible hose is preferred, use a reinforced hose rated for the proper temperature, pressure and chemical resistance against the fluid being pumped.
 - The suction valve must be completely open to avoid restricting the suction flow.
 - FTI advises installing a flush system in the piping to allow the pump to be flushed before it is removed from service.
- NOTE: The pump is provided with a provision for a customer installed 1/4" drain in the impeller housing. See the Drain Installation Section for details.
- For units in a suction lift system, install appropriate piping in the discharge to allow priming of the pump (DB11/15 models are not self-priming).
 - When installing pumps with flanges, we recommend use of low seating stress gaskets such as Gore-Tex® or Gylon® (expanded PTFE).

Section II - Installation

Mounting

Pump foot should be securely fastened to a solid foundation. If the pump was received with plastic shipping shims, these shims may be used as additional support for the motor feet (though not required).

Motor/Electrical

Only qualified personnel trained in the safe installation and operation of this equipment should install the motor. Install the motor according to National Electric Code, NEMA MG-2, IEC standards requirements and/or applicable local electrical codes. The voltage and frequency variations of the power supply should never exceed the limits established in the applicable standard. Prior to connecting to the power line, check nameplate voltage, rotation connection and ensure proper grounding. Sufficient ventilation area should be provided to insure proper operation and cooling of the motor. The motor must be installed with a suitable overload protection circuit. For three phase motors it is recommended to install a phase failure protection device. Download the motor manual from the specific motor manufacturers' website for additional information concerning motor installation, safety and maintenance instructions.

Wire the motor for clockwise rotation when facing the fan end of the motor.

⚠ CAUTION: Do not operate the pump to check rotation until the pump is full of liquid or damage may occur even if the motor is "bumped" to check motor rotation direction.

Check all electrical connections with the wiring diagram on the motor. Make sure the voltage, frequency, phase and amp draw comply with the supply circuit.

If utilized, verify that power monitors or variable frequency drives have been properly installed according to the manufacturer's instructions

To verify correct rotation of the motor:

1. Install the pump into the system.
2. Fully open the suction and discharge valves.
3. Allow fluid to flow into the pump. Do not allow the pump to run dry (ceramic, PTFE and silicon carbide bushings can't be run dry without damage to pump components).
4. Jog the motor (allow it to run for 1-2 seconds) and observe the rotation of the motor fan. Refer to the directional arrow molded into the pump casing if necessary.

NOTE: A pump running backwards will pump but at a greatly reduced flow and pressure.

Section III - Start-up and Operation

1. This pump must be filled from a flooded suction tank (gravity) or primed with liquid from an outside source. The DB11/15 is not self-priming.
2. Open the inlet (suction) and discharge valves completely and allow the pump to fill with liquid.
3. Close the discharge valve.
4. Turn the pump on. Slowly open the discharge valve. Adjust the flow rate and pressure by regulating the discharge valve. Do not attempt to adjust the flow with the suction valve.
5. Use of a power monitor is strongly recommended for pumps with ceramic, PTFE or silicon carbide bushings. The power monitor will stop the pump and help prevent damage if the pump should run dry. ATEX certified pumps MUST use a

power monitor.

Shutdown

Use the following procedure to shutdown the pump.

1. Slowly close the discharge valve.
2. Turn off the motor.
3. Close the suction valve.

Flush Systems

⚠ CAUTION: Some fluids react with water; use compatible flushing fluid.

1. Turn off the pump.
2. Completely close the suction and discharge valves.
3. Connect flushing fluid supply to flush inlet valve.
4. Connect flushing fluid drain to flush drain valve.
5. Open flushing inlet and outlet valves. Flush system until the pump is clean.

Optional Drain Installation

1. Remove the impeller housing from the pump assembly.
2. Clamp the impeller housing to a drill press table.
3. Using a 7/16" drill and the molded boss as a guide, drill completely through the molded boss into the interior of the impeller housing. De-burr the hole on the inside of the impeller housing.

⚠ CAUTION - Do not tap too deep or the impeller housing may be damaged.

4. Using a 1/4" NPT tap, tap the hole in the molded boss to the appropriate depth.
5. Install the drain plug or valve, being careful not to overtighten.

Section IV - Maintenance

Recommended maintenance schedule

The recommended maintenance schedule depends upon the nature of the fluid being pumped and the specific application. If the pump is used on a clean fluid, it is recommended that the pump be removed from service and examined after six months of operation or after 2,000 hours of operation. If the pump is used on fluids with solids, high temperatures or other items that could cause accelerated wear, then this initial examination should be sooner.

After the initial examination of the internal components and wear items are measured, a specific maintenance schedule can be determined. For best results, it is recommended that the pump be removed from service annually for examination.

Section V - Disassembly

⚠ WARNING: Rotating Parts. This pump has components that rotate while in operation. Follow local safety standards for locking out the motor from the power supply during maintenance or service.

⚠ WARNING: Chemical Hazard. This pump is used for transferring many types of potentially dangerous chemicals. *Always* wear protective clothing, eye protection and follow standard safety procedures when handling corrosive or personally harmful materials. Proper procedures should be followed for draining and decontaminating the pump before disassembly and inspection of the pump. There may be small quantities of chemicals present during inspection.

⚠ WARNING: Magnetic force hazard. This pump should only be disassembled and assembled using the recommended procedures. The magnetic attraction is powerful enough to rapidly pull the motor end and the wet end together. Do not place fingers between the mating surfaces of the motor and wet ends to avoid injuries. Keep the drive magnet and impeller assembly away from metal chips or particles.

1. Stop the pump, lock out the motor starter, close all the valves that are connected to the pump, and drain/decontaminate the pump.

⚠ WARNING: The pump must be thoroughly flushed of any hazardous materials and all internal pressure relieved prior to opening the pump. Allow the pump to reach ambient temperatures prior to performing maintenance.

2. For pumps with motors 2 horsepower (1.5 kW) or smaller, securely clamp the pump feet to the bench. Remove the (4) bolts, lock washers and flat washers (items 15,16,17) securing the pump to the motor. See figure 9.



Figure 9

Firmly grab the motor and pull straight back to disengage the motor and pump. See figure 11. For pumps with mo-

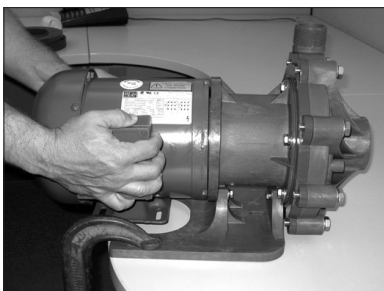

Figure 11

tors 3 HP (2.2 kW) or larger, place the pump and motor on the floor. Remove the (4) bolts, lock washers and flat washers (items 15,16,17) securing the pump to the motor. See figure 9. Make sure the motor is on the fan end with the pump facing up. Pull straight up to remove the pump from the motor. See figure 12.



Figure 12

3. Place pump on bench with housing facing up. Remove (8) 10 mm housing bolts, lock washers and flat washers (items 12, 13, 14). See figure 13.

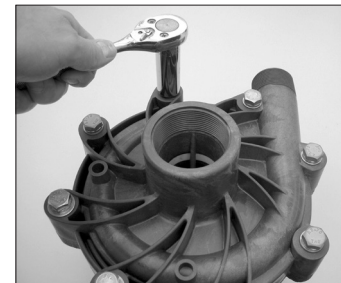

Figure 13

4. Pull housing (item 1) straight up to remove. Inspect housing for signs of wear or damage. Look for signs of rubbing, cracking on thrust ring, or damage to front shaft support. See figure 14.



Figure 14

5. Remove impeller/inner drive assembly (items 4A, 4, 5, 5A). Inspect impeller and drive for signs of wear or damage. Look for signs of rubbing or damage and wear to the impeller and inner drive. See figure 15.



Figure 15

Check the impeller thrust ring and bushing for wear. See figure 16.

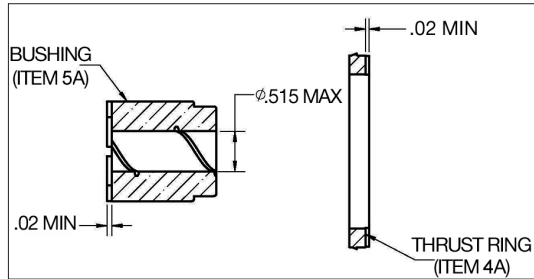

Figure 16

6. Remove the impeller shaft (item 6) from the barrier and check for signs of cracking, chipping, scoring or wear. See figure 17.



Figure 17

7. Remove the barrier (item 7) from the motor adapter (item 8). Make sure the spindle has been removed. Pry the barrier out with your hand. Inspect the inside and outside of the barrier for signs of rubbing. See figure 18.

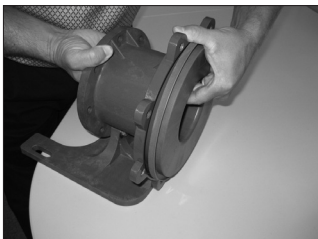

Figure 18

8. Remove the o-ring (item 2) from the barrier and inspect for chemical attack, swelling, brittleness, cuts, etc.
9. Visually inspect the outer drive (item 9) for rubbing, damage, corrosion or loose magnets.

Outer Drive Replacement

1. Remove the setscrews (item 9A) from the side of the drive (NEMA motors) or the bolt, lock washer and flat washer (items 18, 19, 20) from the center of the drive (metric motors).

! WARNING: Be careful, tools will want to be attracted to the magnets.

2. Remove the drive magnet from the motor shaft by gently prying up from the bottom of the drive. See figure 19.



Figure 19

3. To reinstall the drive or a new drive follow the instructions from Section I - Assembly, Pumps without Motors, steps 4-6.

Thrust Ring Replacement

1. Thrust ring (item 4A) is held in-place with a snap fit with a ridge. Using a razor knife or side cutters, cut a notch out of the thrust ring. Pull ring up and out of the holder. See figures 20-21.

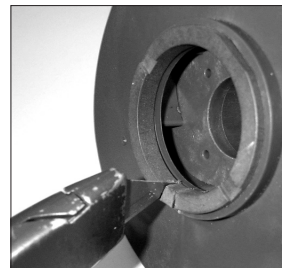

Figure 20

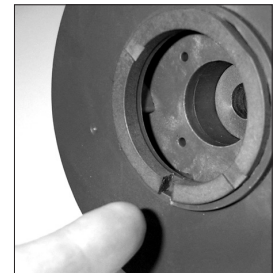

Figure 21

2. To reinstall, align the two flats on the thrust ring with the flats in the bore of the impeller. Using a piece of wood, press into place using an arbor press until the thrust ring is completely seated in the impeller.

Bushing Replacement

1. To remove the bushing, place the impeller/inner drive assembly in an arbor press. Insert a 3/4" diameter plastic or wood shaft through the eye of the impeller and press the bushing out.
2. To replace the bushing (item 5A), place the top of the impeller on an arbor press with the thrust ring face down. Insert the front of the bushing (figure 22) into the center of the impeller/inner drive magnet assembly, aligning the flat on the bushing with the flat in the bore of the inner drive magnet. Using a soft arbor, press into place until the bushing reaches the shoulder molded into the inner drive (figures 23 and 24).



Figure 22



Figure 23



Figure 24

Impeller Replacement

⚠ Caution: Do not damage the outer surface of the inner drive magnet during impeller replacement.

Using the two slots provided, insert a flat blade screw driver into them and pry the impeller (items 4, 4A) up from the body of the inner drive magnet (items 5, 5A). Once a gap has been established, work around the perimeter to evenly increase the gap until the impeller can be removed. See figure 25.

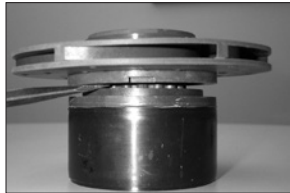

Figure 25

To install a new impeller, place the inner drive magnet assembly face up (splines facing up) on an arbor press. Align the splines in the impeller with the ones in the bore on the inner drive magnet. Place a piece of wood over the top of the impeller thrust ring. Using an arbor press, push down on the impeller until it is completely seated in the inner drive.

Section VI - Clamp Ring Replacement & Reassembly

1. Inspect the clamp ring. If clamp ring requires replacement, it is recommended to remove the plastic foot (Item 11) first. Note: 100/112 frame B5 adapters do not use the foot. See figures 26 & 27. Remove the 4-M6 bolts (items 24 & 24A).

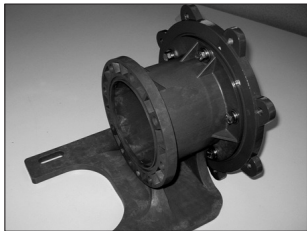

Figure 26

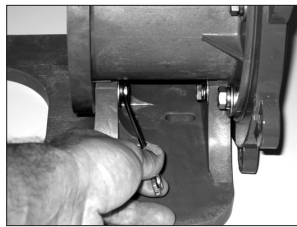

Figure 27

2. Remove the (5) M8 bolts, lock washers & flat washers (items 29, 28 & 27) from the clamp ring (item 8B). See figure 28. Remove the clamp ring from the motor adapter. There is a snug fit between the clamp ring & motor adapter due to the vapor protection o-ring (item 8C). Carefully pull the two parts apart. See figure 29.

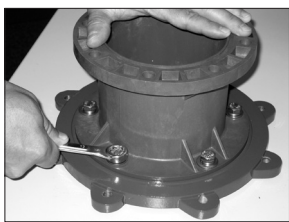

Figure 28



Figure 29

3. Inspect the motor adapter o-ring (item 8C). If damaged, replace. If reusable, lubricate it with a chemically compatible lubricant. See figure 30.



Figure 30

4. Install the new clamp ring. Place the clamp ring on a flat surface. See figure 31. Align the bolt holes (5 motor adapter and 2 foot bolt holes) on the clamp ring with the bolt holes on the motor adapter. Push the motor adapter straight down onto the clamp ring to seat the o-ring. See figure 32. Install (5) M8 bolts, lock washers and flat washers (items 29, 28 and 27), and tighten in a star pattern to 130 in-lb (14.7 N-m). See figure 33.



Figure 31



Figure 32



Figure 33

5. For 56C, 145TC and 80 frame B14, re-install the plastic foot (item 11) to the motor adapter (item 8D). Use the longer M6 bolts, lock washers and flat washers (items 24A, 25 and 26) for the front bolt holes towards the clamp ring. See figure 34. Use the shorter M6 bolts, lock washers and flat washers (items 24, 25 and 26) for the rear bolt holes towards the motor face. Note: Nuts (item 30) are glued into the rear of the motor adapter to help with the installation of the rear bolts. Make sure the nuts are still in place. See figure 35. Tighten bolts to 5 ft-lbs. (6.7 N-m). For 184 frame, IEC 90, 100/112 frame B14 and 80/90 frame B5, leave the foot off until the motor adapter is installed on the motor. This will allow easier access to the bottom bolt hole in the motor adapter.

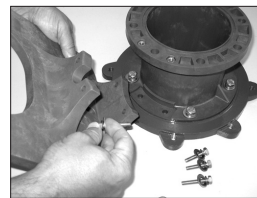

Figure 34

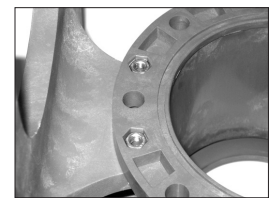

Figure 35

6. Position the motor adapter assembly on a flat surface. If the foot is installed, allow the feet to hang over the edge. See figure 36. Install the o-ring (item 8A) into the groove on the clamp ring. Lubricate the o-ring with a compatible lubricant. See figure 37. Install the barrier (item 7) into the clamp ring motor adapter assembly (items 8A, 8B, 8C, 8D, 27, 28, and 29). Push the barrier straight down until it seats in the clamp ring. See figure 38.



Figure 36



Figure 37



Figure 38

7. Install o-ring (item 2). See figure 39.

8. Install impeller shaft (item 6) into barrier by aligning the flats on the shaft with the ones in the barrier. Make sure it is completely seated. See figure 39.

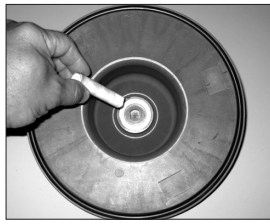

Figure 39

9. Carefully install the impeller/inner drive assembly (items 4, 4A, 5, 5A) by sliding it over the impeller shaft in the barrier. It is normal for the impeller /inner drive to pop up a slight amount due to magnetic forces. See figures 40 and 41.

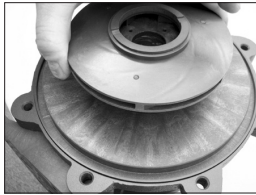

Figure 40



Figure 41

10. Install the impeller housing (item 1). Make sure the discharge is in the correct orientation in relation to pump foot. Align the shaft in the barrier with the front shaft support in the impeller housing. Press down to push the impeller/inner drive magnet assembly into position. Holding the impeller housing with one hand, install and finger-tighten two bolts, lock washers and flat washers (items 12, 13, 14) in opposite locations. See figure 42.

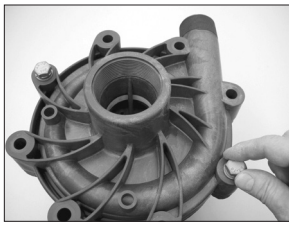

Figure 42

11. Install the remaining bolts, lock washers and flat washers finger tight.

12. Tighten all the bolts evenly using a star pattern. Tighten to 20 foot-lbs (27 N-m).

13. Reinstall the pump on the motor/drive magnet following instructions found in "Assembly, Pumps Without Motors," steps 7-10.

PART NUMBER EXPLANATION

1. Select Base Model (Example: DB11P) *

2. If Standard Components aren't suitable, enter symbol(s) of alternative components in any order.

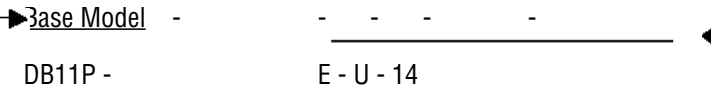

(Example: DB11P-E-U-14 is a DB11P with EPDM o-ring, unions and 145TC motor adapter.)

3. Alternative Components - select from below

*The model number is on the serial number label located on the motor adapter. The model number contains a base model that features certain standard components. Compare the model number on the pump to the chart below to determine if the pump contains any alternate components. Model numbers containing "P" have primary components molded from polypropylene. Model numbers containing "V" have primary components molded from PVDF.

Base Model Numbers: DB11P, DB11V, DB15P, DB15V

BASE MODEL COMPONENTS		ALTERNATIVE COMPONENTS (MAY BE ADDITIONAL COST)	Code								
Bushing	Graphite Carbon	PTFE	T								
		Alumina Ceramic	R								
O-Ring	FKM	EPDM	E								
		Simriz	S								
		Kalrez	K								
Connection	NPT	BSP Threads	B								
		Union	U								
		Steel Reinforced Flange - ANSI 150 / PN20/40 / JIS 10K	Fs								
		FRP Flange - ANSI 150 / PN20/40 / JIS 10K	Ff								
Impeller	1 (Max size 60 Hz)	Select impeller									
		2	3	4	5	6	7	8	9	10	11
Magnet	DB11: 6-Pole DB15: 8-Pole (Upgrade or down-grade for specific gravity corrections)	6-Pole: up to 2 hp (1.5 kW) 56C/145/80/90 frames	6p								
		8-Pole: up to up to 3 hp (2.2 kW) 56C/145TC/80/90 frames	8p								
		10-Pole: up to 5 hp (4 kW) 184TC/100/112 and gas engine frames	10p								
Motor Adapter	56C NEMA	143/145TC NEMA	14								
		182/184TC NEMA	18								
		IEC 63/B14	64								
		IEC 71/B14	74								
		IEC 80/B14	84								
		IEC 90/B14	94								
		IEC 100/B14	04								
		IEC 112/B14	24								
		IEC 63/B5	65								
		IEC 71/B5	75								
		IEC 80/B5	85								
		IEC 90/B5	95								
		IEC 100/B5	05								
		IEC 112/B5	25								
		Gas engine mounting	GE								
Specials		SiC bushing, thrust ring, shaft	Si								
		Hastelloy shaft	Hs								
		Titanium hardware	Ti								
		ATEX (PVDF only)	A								
		Non-sparking ring	Ns								
		316SS clamp ring	Sr								
Motor	Not Standard	Contact factory for motor details									

DB11 / DB15 Exploded View - Parts Diagram

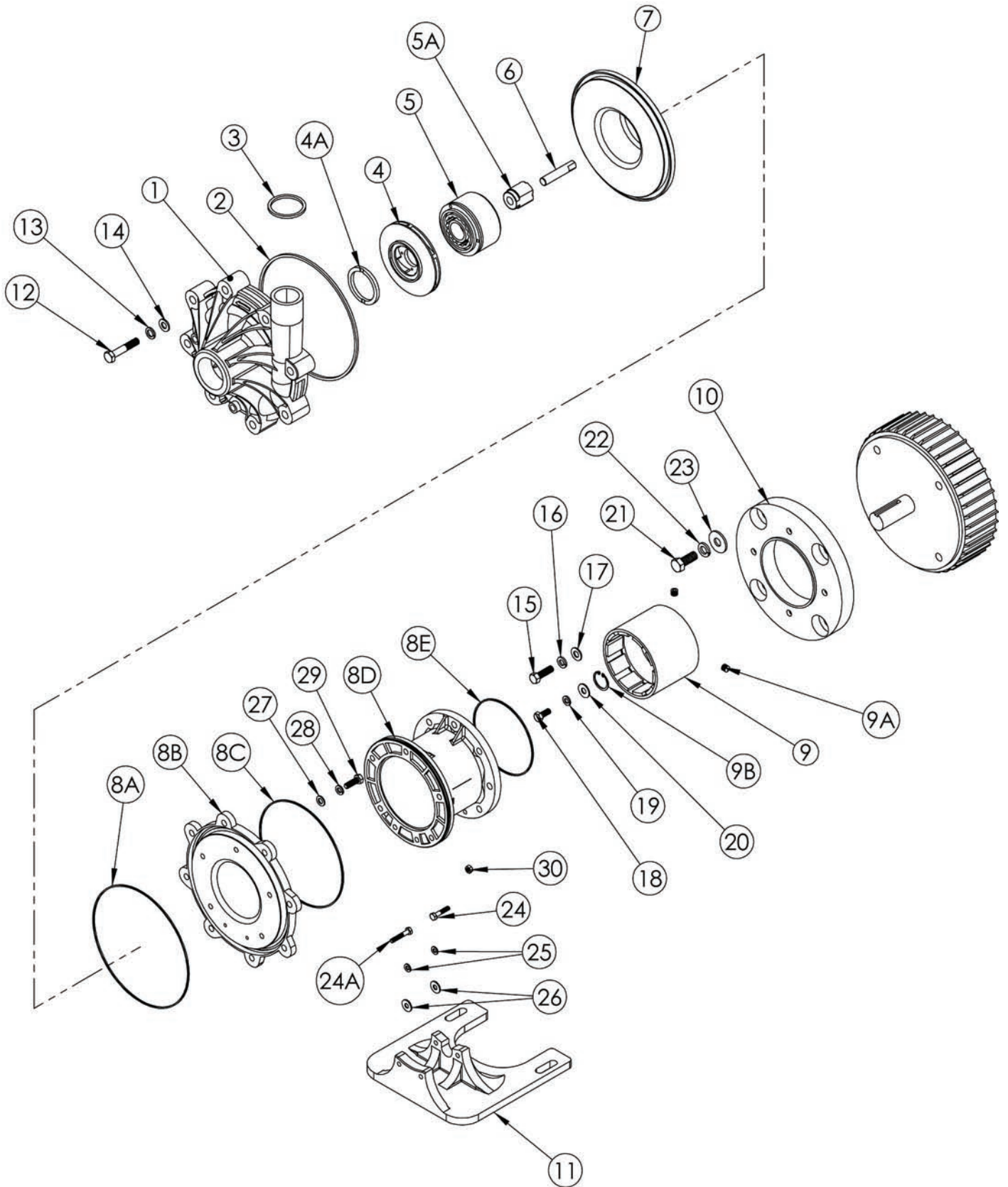

DB11/15 Spare Parts List

Item	Qty	Description	DB11		DB15			
			Pump Material		Pump Material			
			Polypro	PVDF	Polypro	PVDF		
1	1	Standard Housing with Ring						
		NPT threads & standard alumina ceramic ring	105688-1	105688-3	105739-1	105739-3		
		BSP threads & standard alumina ceramic ring	105688-5	105688-7	105739-5	105739-7		
		Steel flanges & std. alumina ceramic ring - ANSI150/PN20/40/JIS10K	105744-1	105744-2	105745-1	105745-2		
		FRP flanges & std. alumina ceramic ring - ANSI150/PN20/40/JIS10K	105744-5	105744-6	105745-5	105745-6		
		Union & standard alumina ceramic ring	105746-1	105746-3	105747-1	105747-3		
		NPT threads & optional SiC ring	105903	105903-1	105904	105904-2		
		BSP threads & optional SiC ring	105903-4	105903-5	105904-4	105904-6		
		Steel flanges & optional SiC ring - ANSI150/PN20/40/JIS10K	105905	105905-1	105924	105924-1		
		FRP flanges & optional SiC ring - ANSI150/PN20/40/JIS10K	105905-4	105905-5	105924-4	105924-5		
Unions & optional SiC ring	105906	105906-2	105923	105923-2				
2	1	Housing O-ring						
		EPDM (optional)			105717			
		FKM (standard)			105716			
		Kalrez (optional)			105718			
		Simriz (optional)			105719			
3	1	Discharge O-ring (BSP Threaded Housings Only)						
		EPDM (optional)			105918			
		FKM (standard)			105919			
		Kalrez (optional)			105920			
		Simriz (optional)			105921			
4	1	Impeller Assembly with Thrust Ring						
<i>See DB11/15 Impeller Assemblies Table on pg 19</i>								
4A	1	Impeller Thrust Ring Only						
		Filled PTFE (standard)			105694-1			
		Silicon Carbide (optional)			105694-3			
5	1	Impeller Drive Assembly						
		6-pole w/ carbon bushing	105913	105913-3	105913	105913-3		
		8-pole w/ carbon bushing	105913-1	105913-4	105913-1	105913-4		
		10-pole w/ carbon bushing	105913-2	105913-5	105913-2	105913-5		
		6-pole w/ PTFE bushing	105913-6	105913-9	105913-6	105913-9		
		8-pole w/ PTFE bushing	105913-7	105913-10	105913-7	105913-10		
		10-pole w/ PTFE bushing	105913-8	105913-11	105913-8	105913-11		
		6-pole w/ alumina ceramic bushing	105913-12	105913-15	105913-12	105913-15		
		8-pole w/ alumina ceramic bushing	105913-13	105913-16	105913-13	105913-16		
		10-pole w/ alumina ceramic bushing	105913-14	105913-17	105913-14	105913-17		
		6-pole w/ silicon carbide bushing	105913-18	105913-21	105913-18	105913-21		
		8-pole w/ silicon carbide bushing	105913-19	105913-22	105913-19	105913-22		
		10-pole w/ silicon carbide bushing	105913-20	105913-23	105913-20	105913-23		
5A	1	Impeller Bushing Only						
		Carbon (standard)			J100977			
		Filled PTFE (optional)			106386			
		Alumina Ceramic (optional)			106386-2			
		Silicon Carbide (optional)			106386-1			
6	1	Impeller Shaft						
		Alumina Ceramic (standard)			105811-1			
		Silicon Carbide (optional)			105811-2			
		Hastelloy C (optional)			105811-3			
7	1	Barrier						
			105689-1	105689-2	105689-1	105689-2		

DB11/15 Spare Parts List - cont.

Item	Qty	Description	DB11		DB15	
			Pump Material		Pump Material	
			Polypro	PVDF	Polypro	PVDF
8	1	Motor Adapter Kits (includes items 8A - 8E plus hardware)				
		Standard motor adapter - all frame sizes	107405	107406	107405	107406
		Standard motor adapter w/ non-sparking ring - all frame sizes	107407	107408	107407	107408
		ATEX motor adapter w/ PVDF motor adapter & non-sparking ring - all frame sizes	N/A	107413	N/A	107413
		<i>Note: 182/184TC & all IEC frames MAY need to order motor adapter flange (item 10) and hardware (items 15-17 & 21-23)</i>				
8A	1	Barrier/Clamp O-ring				
		Buna	107281			
		FKM	107279			
		EPDM	107280			
8B	1	Clamp Ring				
		Painted cast iron (Standard)	107228	107228-1	107228	107228-1
		Painted cast iron with non-sparking ring	107321	107321-1	107321	107321-1
		Painted cast iron (ATEX)	N/A	107321-1	N/A	107321-1
		Stainless steel	108600	108600	108600	108600
		Stainless steel with non-sparking ring	108600-1	108600-1	108600-1	108600-1
		Stainless steel (ATEX)	N/A	108600-1	N/A	108600-1
8C	1	Clamp Ring/Motor O-ring				
		Buna	107282			
		FKM	107283			
		EPDM	107284			
8D	1	Motor Adapter Column				
		Standard	106890	106890-1	106890	106890-1
		ATEX	N/A	106890-2	N/A	106890-2
8E	1	Motor Adapter Column/Motor O-ring (NEMA 56C/143/143/145TC motors only)				
		Buna	106549			
		FKM	106374			
		EPDM	106373			
9	1	Drive Magnet Assembly with Snap Ring				
		6-pole 56C frame (includes set screws)	105878			
		8-pole 56C frame (includes set screws)	105878-1			
		6-pole 143/145TC frame (includes set screws)	105878-3			
		8-pole 143/145TC frame (includes set screws)	105878-4			
		10-pole 182/184TC frame (includes set screws)	105730-9			
		6-pole 80 frame	105882			
		8-pole 80 frame	105882-1			
		6-pole 90 frame	105882-3			
		8-pole 90 frame	105882-4			
10-pole 100/112 frame	105730-18					
9A	2	Set Screws				
		NEMA motor frames only	J101084			
9B	1	Snap Ring				
		56C frame	105708			
		143/145TC frame	105709			
		182/184TC frame	105710			
		80 frame	105711			
		90 frame	105712			
100/112 frame	105710					

*Cast iron motor adapters have been upgraded to polypropylene effective August 2009. To upgrade, order one of the options in item 8 above. For IEC 80, 90, 100 & 112 B5 frames, you will also need one of the options in item 10.

DB11/15 Spare Parts List - cont.

Item	Qty	Description	DB11		DB15	
			Pump Material		Pump Material	
			Polypro	PVDF	Polypro	PVDF
10	1	Motor Adapter Flange				
		182/184TC frame	105751-1	105751-2	105751-1	105751-2
		80 frame B14	105724-1	105724-2	105724-1	105724-2
		90 frame B14	105725-1	105725-2	105725-1	105725-2
		100/112 frame B14	105726-1	105726-2	105726-1	105726-2
		80/90 frame B5	106274	106274-1	106274	106274-1
		100/112 frame B5	107315	107315-1	107315	107315-1
		80 frame B14 ATEX	N/A	105724-3	N/A	105724-3
		90 frame B14 ATEX	N/A	105725-3	N/A	105725-3
		100/112 frame B14 ATEX	N/A	105726-3	N/A	105726-3
		80/90 frame B5 ATEX	N/A	106274-2	N/A	106274-2
100/112 frame B5 ATEX	N/A	107315-1	N/A	107315-1		
11	1	Foot (Pumps with 100/112-B5 frames and flange do not come with a foot)				
		All frames sizes except 100/112	105691-1	105691-4	105691-1	105691-4
		100 frame with B14 flange only	105691-3	105691-6	105691-3	105691-6
		112 frame with B14 flange only	105691-2	105691-5	105691-2	105691-5

DB11/15 Impeller Assemblies													
DB11	Thrust Ring Material	Impeller Material	#1	#2	#3	#4	#5	#6	#7	#8	#9	#10	#11
						4.63"	4.38"	4.13"	3.88"	3.63"	5.25"	5.00"	4.75"
DB11	PTFE	Polypro	105911	105911-4	105911-6	105911-8	105911-10	105911-2	105911-14	105911-16	105911-18	105911-20	105911-22
		PVDF	105911-1	105911-5	105911-7	105911-9	105911-11	105911-3	105911-15	105911-17	105911-19	105911-21	105911-23
	SiC	Polypro	105915	105915-4	105915-6	105915-8	105915-10	105915-2	105915-14	1205915-16	105915-18	105915-20	105915-22
		PVDF	105915-1	105915-5	105915-7	105915-9	105915-11	105915-3	105915-15	105915-17	105915-19	105915-21	105915-23
DB15	Thrust Ring Material	Impeller Material	#1	#2	#3	#4	#5	#6	#7	#8	#9		
			5.13"	5.00"	4.75"	4.50"	4.25"	5.75"	5.50"	5.25"	5.00"		
	PTFE	Polypro	105911-12	105916	105916-4	105916-6	105916-8	105916-1	105916-10	105916-12	105916-14		
		PVDF	105911-13	105916-2	105916-5	105916-7	105916-9	105916-3	105916-11	105916-13	105916-15		
	SiC	Polypro	105915-12	105917	105917-4	105917-6	105917-8	105917-1	105917-10	105917-12	105917-14		
		PVDF	105915-13	105917-2	105917-5	105917-7	105917-9	105917-3	105917-11	105917-13	105917-15		

All impeller diameters listed in inches.

HARDWARE - ALL DB11-15 MODELS

Item	Qty	Description	Stainless Steel	Titanium
12	8	Housing Bolt		
			105755	105756
13	8	Housing Lockwasher		
			105757	105758
14	8	Housing Flat Washer		
			105722	105773
15	4	Motor Adapter Bolt		
		All frames except 100/112 B5	J103118	105752
		100/112 B5 frames only	J100114	106311
16	4	Motor Adapter Lockwashers		
			J100115	J104206
17	4	Motor Adapter Flatwashers		
			J100128	J104207
18	1	Drive Bolt (IEC Frames Only)		
		80 frame IEC	105765	105766
		90 frame IEC	105770	105771
		100/112 frame IEC	105774	105775
19	1	Drive Lock Washer (IEC Frames Only)		
		80 frame IEC	J100672	J104203
		90 frame IEC	J102282	J103847
		100/112 frame IEC	J100115	J104206
20	1	Drive Flat Washer (IEC Frames Only)		
		80 frame IEC	105767	105768
		90 frame IEC	105722	105773
		100/112 frame IEC	J101360	106200
21*	4	Motor Adapter Flange Bolts		
		182/184TC frame	J103782	105761
		80 frame with B14 flange	105765	105764
		90 frame with B14 flange	105770	105771
		100/112 frame with B14 flange	105770	105771
22*	4	Motor Adapter Flange Lock Washer		
		182/184TC frame	J101023	105762
		80 frame with B14 flange	J100672	J104203
		90 frame with B14 flange	J102282	J103847
		100/112 frame with B14 flange	J102282	J103847
23*	4	Motor Adapter Flange Flat Washer		
		182/184TC frame	J103851	105763
		80 frame with B14 flange	J100113	J104204
		90 frame with B14 flange	J101293	J103845
		100/112 frame with B14 flange	J101293	J103845
24	2	Rear Foot Bolt		
			J103968	107288
24A	2	Front Foot Bolt		
			107289	107290
25	4	Foot Lock Washer		
			J100672	J104203
26	4	Foot Flat Washer		
			J100113	J104204
27	5	Clamp Ring Flat Washer		
			J101293	105768
28	5	Clamp Ring Lock Washer		
			J102282	J103847
29	5	Clamp Ring Bolt		
			J103662	107285
30	2	Nut		
		For rear foot bolt	107286	107287

*For IEC B5 frame pumps: Hardware is to be supplied by customer due to variations in B5 frame motors.

Section VII - Troubleshooting

General Notes:

- Do not pump liquids containing ferrous metal fines.
- If magnets decouple, stop pump immediately. Operating the pump with the magnets decoupled will eventually weaken the magnets.
- Power monitors are required and must be used with all ATEX certified pumps.
- Do not use mismatched drive magnet assemblies (different number of magnets on inner and outer drive magnet assemblies).
- Contact our Technical Service Department -
Phone: 1-800-888-3743
Email: techservice@finishthompson.com
if you have any questions regarding product operation or repair.

No or Insufficient Discharge

- Air leaks in suction piping
- Pump not primed
- System head higher than anticipated
- Closed valve
- Viscosity or specific gravity too high
- Motor too large for magnet coupling rating (magnets uncoupled)
- Suction lift too high or insufficient NPSH
- Clogged suction line or impeller vanes
- Motor rotation incorrect (correct rotation when viewed from the fan end is clockwise)

Insufficient Pressure

- Air or gas in liquid
- Impeller diameter too small
- System head lower than anticipated
- Motors speed insufficient (too low) or motor rotation incorrect (correct rotation when viewed from the fan end is clockwise)

Loss of Prime

- Leak in suction piping
- Foot valve or suction opening not submerged enough
- Foot valve too small or leaking
- Air or gas in liquid

- Foreign matter in impeller
- Leaking valve. Suction lift too high or insufficient NPSHa

Excessive Power Consumption

- Head lower than rating
- Excessive flow
- Specific gravity or viscosity too high.

Vibration/Noise

- Loose magnet
- Drive magnet rubbing
- Pump cavitating from improper suction or feed
- Motor or piping not properly secured
- Foreign object in impeller

Section VIII - Warranty

Finish Thompson, Inc (manufacturer) warrants this pump product to be free of defects in materials and workmanship for a period of **five years** from date of purchase by original purchaser. If a warranted defect, which is determined by manufacturer's inspection, occurs within this period, it will be repaired or replaced at the manufacturer's option, provided (1) the product is submitted with proof of purchase date and (2) transportation charges are prepaid to the manufacturer. Liability under this warranty is expressly limited to repairing or replacing the product or parts thereof and is in lieu of any other warranties, either expressed or implied. This warranty does not apply to normal wear of the product or components. This warranty does not apply to products or parts broken due to, in whole or in part, accident, overload, abuse, chemical attack, tampering, or alteration. The warranty does not apply to any other equipment used or purchased in combination with this product. The manufacturer accepts no responsibility for product damage or personal injuries sustained when the product is modified in any way. If this warranty does not apply, the purchaser shall bear all cost for labor, material and transportation.

Manufacturer shall not be liable for incidental or consequential damages including, but not limited to, process down time, transportation costs, costs associated with replacement or substitution products, labor costs, product installation or removal costs, or loss of profit. In any and all events, manufacturer's liability shall not exceed the purchase price of the product and/or accessories.

Warranty Registration

Thank you for your purchase of this quality Finish Thompson product. Be sure to take a minute to register your pump at Finishthompson.com/warranty. Simply provide the model number, serial number and a few other pieces of information.

Ordering Spare Parts

Spare parts can be ordered from your local distributor. Always refer to the pump model to avoid error.



FINISH THOMPSON INC.

921 Greengarden Road • Erie, PA 16501-1591 U.S.A.
Ph 814-455-4478 • Fax 814-455-8518
Email fti@finishthompson.com • www.finishthompson.com

Part Number 107403 R20, 4/20/2020
Order fax: 814-459-3460
Tech Service: 800-888-3743

