

SP11/15 SERIES SELF-PRIMING PUMPS

ASSEMBLY, INSTALLATION AND OPERATION MANUAL

P/N 107404 R18



FINISH THOMPSON INC.



FINISH THOMPSON INC.

921 Greengarden Road • Erie, PA 16501-1591 U.S.A.

Ph 814-455-4478 • Fax 814-455-8518

Email fti@finishthompson.com • www.finishthompson.com

EU Declaration of Conformity



Finish Thompson Inc. hereby declares that the following machine(s) fully comply with the applicable health and safety requirements as specified by the EU Directives listed. The product may not be taken into service until it has been established that the drive motor for the centrifugal pump complies with the provisions of all relevant EU Directives. The complete product complies with the provisions of the EC Directive on machinery safety provided motors carry CE marking.

This declaration is valid provided that the devices are fully assembled and no modifications are made to these devices.

Type of Device:

Centrifugal Pumps

Models:

AC/AK/AV - 400/500/600/800

GP-11/22/32

VKC-5.5/6/6H/7/8/10

DB-3/4/5/5.5/6/6H/7/8/9/10/11/15/22

MSKC

SP-10/11/15/22

KC-3/4/5/5.5/6/6H/8/10/11/22/32

MSVKC

UC-1516/1516L/1518/1518L/2110/3158/326/326H/328/436/438/4310H/326H/4310H/6410

EU Directives:

Machinery Safety (2006/42/EC)

Applied Harmonized Standards:

EN ISO 12100

EN 809

Manufacturer: Finish
Thompson Inc.
921 Greengarden Road
Erie, Pennsylvania 16501-1591 U.S.A

Signed,

President

1 August 2016

Person(s) Authorized to Compile Technical File: Finish Thompson GmbH
Otto-Hahn-Strasse 16
Maintal, D-63477 DEU
Telephone: 49 (0)6181-90878-0

Table of Contents

Model/Serial Number.....	4
Important Notice	4
Chemical Reaction Disclaimer.....	4
Safety Precautions	4-5
SP11/15 Capabilities	5
Priming Times.....	6
Section 1 - Assembly	7
Section II - Installation	9
Section III - Start-up and Operation.....	10
Section IV - Shut Down	11
Section V - Disassembly.....	11
Section VI - Clamp Ring Replacement and Reassembly	15
Part Number Explanation	18
SP11/15 Parts Diagram	19
SP11/15 Spare Parts List	20-24
Section VII - Troubleshooting	25
Section VIII - Warranty.....	26

FTI Contacts:

Tech Service: 1-800-888-3743; techservice@finishthompson.com

Order Fax: 1-814-459-3460 or 1-814-455-8518

Sales: 1-800-934-9384 (toll free U.S. and Canada; 1-814-455-4478)

Model Number and Serial Number

Record the model number and serial number below for future reference. This is important information when ordering replacement parts or when technical assistance is required. The numbers are found on a label located on the motor adapter.

MODEL NUMBER = _____

SERIAL NUMBER = _____

IMPORTANT NOTICE

U.S. Export Administration Regulations, pursuant to ECCN 2B350, prohibit the export or reexport to certain enumerated countries of sealless centrifugal pumps in which all wetted materials are constructed from fluoropolymers without first applying for and obtaining a license from the U.S. Bureau of Industry and Security (BIS). This affects all Finish Thompson magnetic-drive pumps constructed from PVDF or lined with ETFE. Please contact the BIS (www.bis.doc.gov) or Finish Thompson with questions regarding the Regulations or a list of the countries to which they apply.

Chemical Reaction Disclaimer

The user must exercise primary responsibility in selecting the product's materials of construction, which are compatible with the fluid(s) that come(s) in contact with the product. The user may consult Finish Thompson, Inc. (manufacturer) and a manufacturer's representative/distributor agent to seek a recommendation of the product's material of construction that offers the optimum available chemical compatibility.

However neither manufacturer nor agent shall be liable for product damage or failure, injuries, or any other damage or loss arising out of a reaction, interaction or any chemical effect that occurs between the materials of the product's construction and fluids that come into contact with the product's components.

Safety Precautions

WARNING: READ THIS MANUAL COMPLETELY BEFORE INSTALLING AND OPERATING THIS UNIT. FAILURE TO FOLLOW THESE PRECAUTIONS CAN RESULT IN SERIOUS INJURY OR DEATH.

⚠ WARNING: Magnetic field hazard. This pump contains powerful magnets. Exposed magnets (pump not connected to motor) produce powerful magnetic fields. Individuals with cardiac pacemakers, implanted defibrillators, other electronic medical devices, metallic prosthetic heart valves, internal wound clips (from surgery), metallic prosthetic devices or sickle cell anemia must not handle or be in the proximity of the magnets contained inside the pump. Consult a health care provider for specific recommendations before working with this pump.

⚠ WARNING: Magnetic force hazard. This pump should only be disassembled and assembled using the recommended procedures. The magnetic attraction is powerful enough to rapidly pull the motor end and the wet end together. Do not place fingers between the mating surfaces of the motor and wet ends to avoid injuries. Keep the drive magnet and impeller assembly away from metal chips or particles, items with magnetic stripes like credit cards and magnetic computer media such as floppy discs and hard drives.

⚠ WARNING: Not Recommended for Pumping Flammable or Combustible Liquids (unless pump is manufactured with ATEX construction and installed in compliance with all applicable ATEX regulations). During the priming process the internal pump atmosphere can become very dangerous should the pump fail to prime and overheat.

If using the SP Series to pump non-flammable or non-combustible liquids in a hazardous area, you must follow these guidelines:

1. Select the Ns (non-sparking) bronze bump ring option. The non-sparking ring is pressed into the clamp ring or motor adapter and prevents sparking should the motor bearings fail and the outer mag drive assembly runs out of round.
2. Select an FTI explosionproof motor or provide your own.
3. Contact Finish Thompson for more information about using pump in ATEX areas.

⚠ WARNING: Hot surfaces. This pump is capable of handling liquids with temperatures as high as 220° F (104° C). This may cause the outer areas of the pump to become hot as well and could cause burns.

⚠ WARNING: Rotating Parts. This pump has components that rotate while in operation. Follow local safety standards

for locking out the motor from the power supply during maintenance or service.

⚠ WARNING: Chemical Hazard. This pump is used for transferring many types of potentially dangerous chemicals. Always wear protective clothing, eye protection and follow standard safety procedures when handling corrosive or personally harmful materials. Proper procedures should be followed for draining and decontaminating the pump before disassembly and inspection of the pump. There may be small quantities of chemicals present during inspection.

⚠ WARNING: Never run pump at less than minimum flow or with the discharge valve closed. This could lead to pump failure.

⚠ WARNING: The pump and associated components are heavy. Failure to properly support the pump during lifting and movement could result in serious injury or damage to the pump and components.

⚠ CAUTION: This pump should never be started without the 1 US gallon (3.8 liters) of priming fluid in the housing. If the pump has a PTFE, ceramic or silicon carbide bushing, **IT CANNOT BE RUN DRY WITHOUT CAUSING DAMAGE TO THE PUMP.** However, the pump can operate without liquid in the housing if the pump has a carbon bushing. The exact length of time the pump can run dry with a carbon bushing varies with operating conditions and environment.

⚠ CAUTION: Never start or operate with a closed suction valve.

⚠ WARNING: Operation without priming or against a closed discharge valve can result in high temperatures that can result in injury or damage to pump components.

⚠ CAUTION: Always provide adequate NPSHa (net positive suction head available). It is recommended to provide at least 2 feet (61 cm) above the NPSHr (net positive suction head required).

⚠ CAUTION: If pump is used on variable speed drive, do not exceed the frequency for which the pump was designed (for example, if the pump is a 50 Hz model, do not exceed 50 Hz).

SP11/15 Capabilities

Maximum Working Pressure: 90 psi (6.2 bar)

Maximum Temperature: Polypropylene: 180° F (82° C); PVDF: 220° F (104° C)

NOTE: Maximum temperature is application dependent. Consult a chemical resistance guide or the chemical manufacturer for chemical compatibility and temperature limits.

Maximum Lift: 25 feet (7.6 meters)

NOTE: Lift determined on fresh, cold water with 1 1/2" Schedule 40 pipe. Specific gravity affects lift capability. Divide 25 feet (7.6 meters) by the specific gravity to determine equivalent maximum lift.

Solids: Maximum particle size is 100 microns for slurries and 1/64" (.4 mm) for occasional solids. Maximum hardness is 80 HS. Maximum concentration is 10% by weight. If solids are being pumped, it is recommended that the pump have either ceramic or for best results, silicon carbide components. Pumping solids may lead to increased wear.

NOTE: While the pump is capable of being used in sump applications, it is **NOT** a trash pump. Care must be taken to ensure that debris and foreign objects do not enter the pump or damage may result. A 1-1/2" strainer basket with 1/8" (32mm) perforations is suggested. Regular strainer basket maintenance is required to prevent plugging and decrease in NPSHa so as not to starve and damage the pump.

Minimum Allowable Flow Rate

Do not allow the flow rate to drop below the minimum flow rate listed in the chart below.

Model	3450 rpm	1725 rpm	2900 rpm	1450 rpm
SP11	4 gpm (.9 m ³ /hr)	2 gpm (.5 m ³ /hr)	.76 m ³ /hr (3.4 gpm)	.38 m ³ /hr (1.7 gpm)
SP15	5 gpm (1.1 m ³ /hr)	2.5 gpm (.6 m ³ /hr)	.95 m ³ /hr (4.2 gpm)	.48 m ³ /hr (2 gpm)

Maximum Noise Level: 78 dBA (pump only)

Maximum Allowable Motor Power

Do not exceed the maximum power rating for the pump coupling.

Standard coupling for the SP11 is 6-pole; standard coupling for the SP15 is 8-pole.

- 6-pole coupling = 2 horsepower (1.5 kW)
- 8-pole coupling = 3 horsepower (2.2 kW)
- 10-pole coupling = 5 horsepower (4 kW)

Priming Liquid Volume

Initial filling (or refilling after maintenance) of the pump housing requires 1 US gallon (3.8 liters) of liquid.

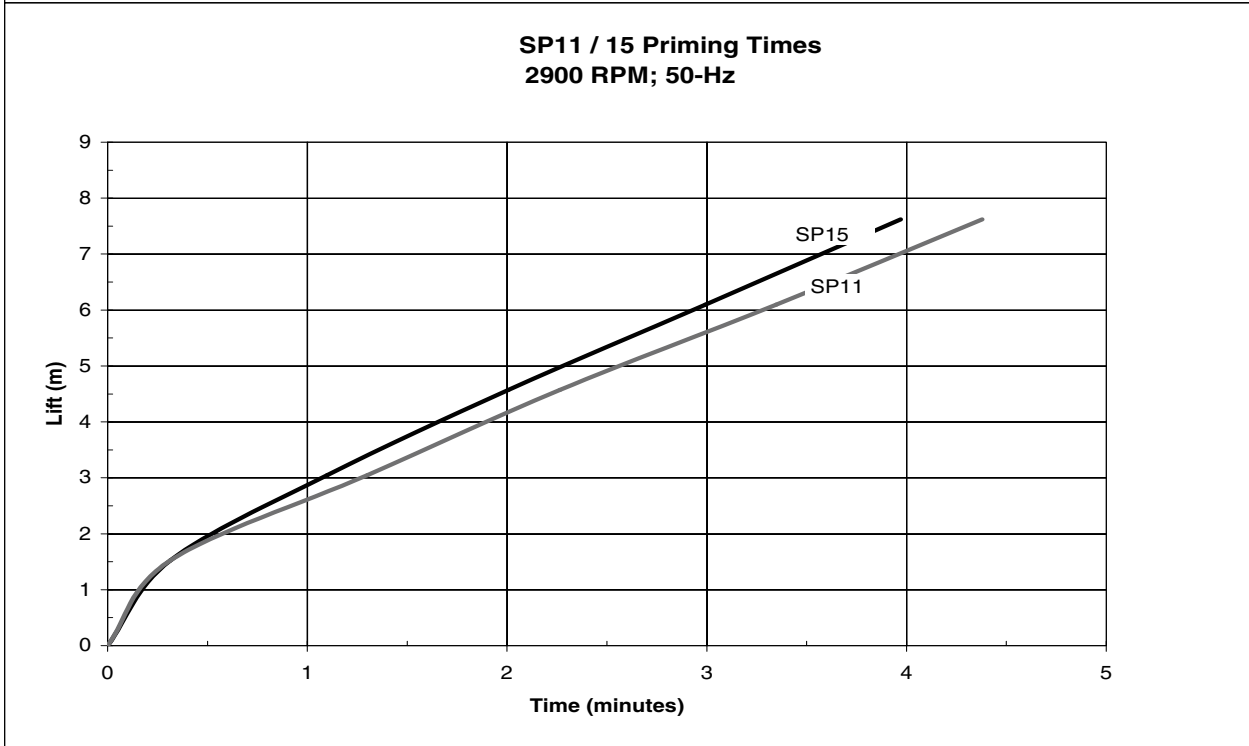
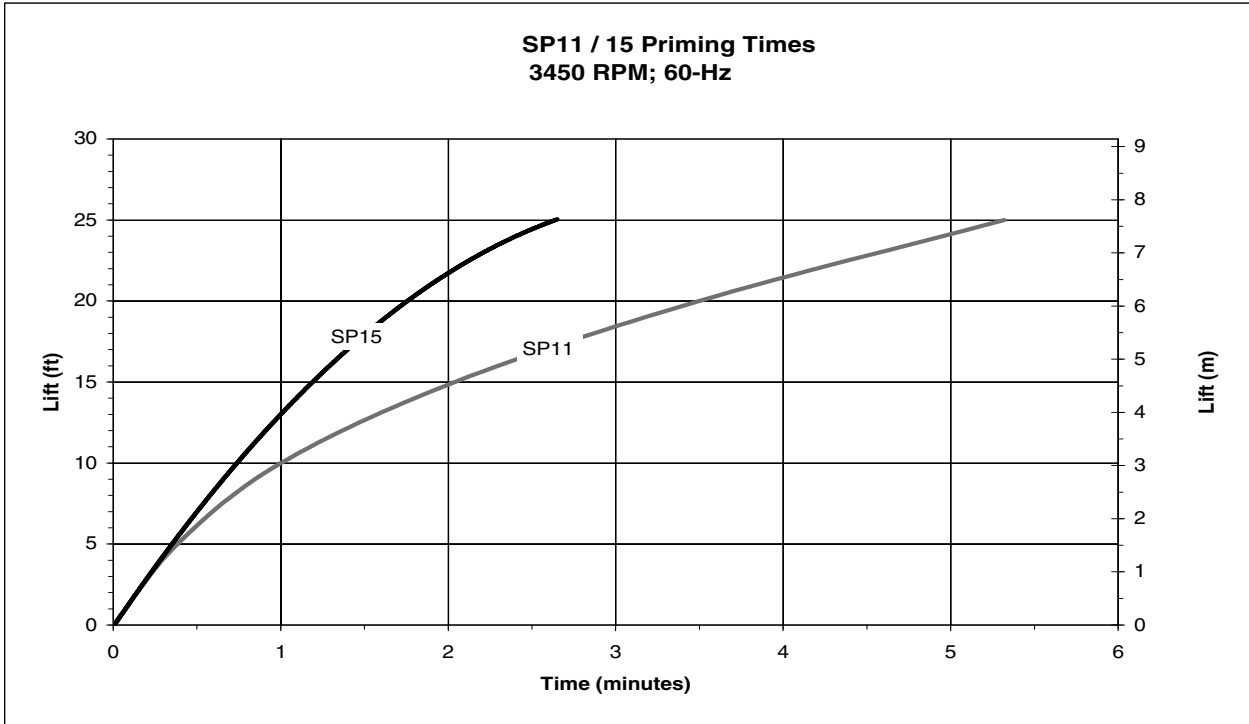

Note: Times shown are guidelines only and may vary depending on system and piping setup

Unpacking and Inspection

Unpack the pump and examine for any signs of shipping damage. If damage is detected, save the packaging and notify the carrier immediately.

Section I - Assembly

Tools Required:

Metric socket or wrench set, 9/16" socket or wrench, 8 mm Allen wrench, and 3/16" Allen bit & torque wrench (NEMA motors only) and pliers (for fill/drain plugs).

The NEMA 182-184TC and IEC 80, 90, 100/112 B14 flange models will require a 1/4" drive ratchet and 9/16" socket to install (items 22, 23, 24) motor adapter bolt, lock washer, and flat washer between the foot.

Pumps with Motors

Proceed to "Installation" Section

Pumps Without Motors

NOTE: 184TC and 100/112 frame motors must have motor feet.

⚠ 1. Remove the pump, drive magnet assembly and hardware package from the carton.

⚠ CAUTION: Keep away from metallic particles, tools and electronics.

⚠ Drive magnets **MUST** be free of metal chips.

WARNING: Keep the drive magnet away from the open end of the motor adapter and barrier. Strong magnetic attraction could allow the drive hub to enter the motor adapter resulting in injury or damage.



Figure 1

2. Place motor on the fan end. For 56C/145TC and B5 frame motors go to step 4. See figure 1.

3. For 184 NEMA and IEC motors only - Install the motor adapter flange (item 14) on the motor face using bolts, lock washers and flat washers (items 25, 26, 27). See figure 2.

NOTE: Apply anti-seize compound on threads of the bolts.

Torque bolts to the following:

- 80 frame (M6) = 90 in-lb (10.2 N-m)
- 90/100/112 frame (M8) = 130 in-lb (14.7 N-m)
- 184 NEMA (1/2") = 480 in-lb (54.3 N-m)

4. Coat the motor shaft with anti-seize compound. Insert key supplied with motor into keyway on motor shaft. See figure 3.

NOTE: Make sure the motor shaft is clean and free of burrs.

The outer drive is precision machined and has a bore tolerance of +.0005/-0 inch.

5. Slide the outer drive magnet assembly (item 13) onto the motor shaft until the motor shaft contacts the snap ring in the bore of the drive. Figures 4 and 5.



Figure 4



Figure 5

6. Secure the drive on the motor shaft.

WARNING: Be careful, magnets will try to attract tools.

⚠ Metric Motors: Secure the drive to the motor shaft using bolt, lock washer and flat washer (items 19, 20, 21). Thread the bolt into the end of the motor shaft (while holding the outer drive to prevent it from turning). See figure 6.

Tighten the bolt to the following:

- * 80 frame (M6) = 90 in-lb (10.2 N-m)
- * 90 frame (M8) = 130 in-lb (14.7 N-m)
- * 100/112 frame (M10) = 240 in-lb (27.1 N-m)

NEMA Motors: Install set screws (item 13A) into threaded holes on the side of the outer drive magnet assembly. Using a 3/16" Allen bit & torque wrench, tighten to 228 in-lbs (25.8 N-m). See figure 7.

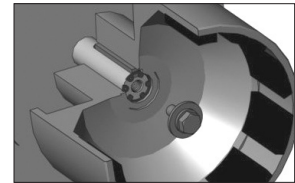

Figure 6 - IEC

7. Install the pump end on the motor/drive magnet assembly. With the motor facing upright, align the pump feet so that the motor feet and pump feet are on the same side.

Tip the pump end at an angle (discharge is approximately 45°) so that it is just touching the edge of the outer drive magnet assembly. See figure 8.

Carefully lower the pump onto the drive magnet assembly by tipping discharge forward to 90° and dropping straight down. The last 3-4 inches (8-10 cm) before the pump reaches the motor will have **STRONG** magnetic attraction between the pump and outer drive magnet assembly.

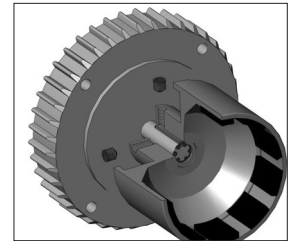

Figure 7 - NEMA

8. Secure the pump to the motor with (4) 3/8" bolts, lock washers and flat washers (items 22, 23, 24). See figures 9 and 10.



Figure 8

NOTE: Apply anti-seize compound on the threads of the bolts.



Figure 9



Figure 10

NOTE: B5 flange motors will require customer supplied hardware.

9. Rotate the motor fan to ensure that there is no binding in the pump.

Section II - Installation

Mounting -

Pump foot should be securely fastened to a solid foundation. If the pump was received with plastic shipping shims, it is possible to use these as additional support for the motor feet (though not required).

NOTE: B5 pumps with 100/112 frame do not include a pump foot.

CAUTION: The NPSH available to the pump must be greater than the NPSH required. The amount of lift, frictional pipe loss and vapor pressure must be calculated into the application. NPSH available should be 2 feet (.6 meters) greater than NPSH required.

SP Piping Diagram

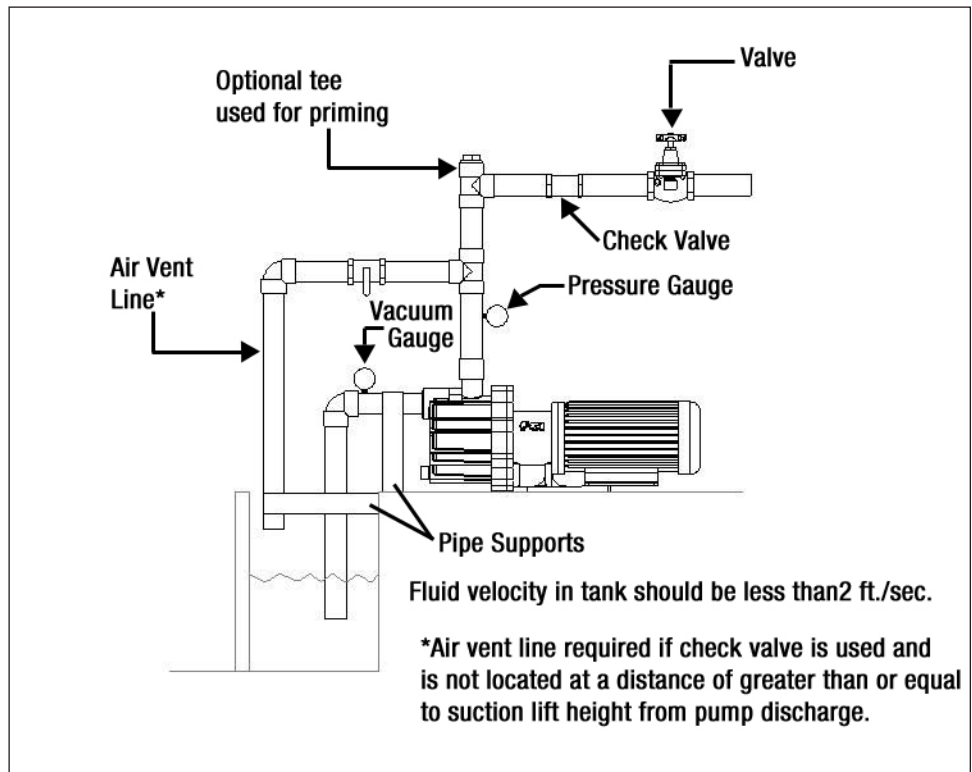

- Total suction lift including pipe friction loss and corrections for specific gravity must not exceed 25 feet (7.6 meters).
NOTE: Maximum suction lift is reduced by 1.13 feet (.34 meters) for every 1,000 feet (304 meters) of altitude.
- Install the pump as close to the suction source as possible.
- SP Series pumps are designed to operate in a horizontal position only with discharge on the top.
- SP Series pumps self-priming capability is due to its ability to create a vacuum in the suction piping. The suction piping **MUST** be airtight at fittings and connections.
- Support the piping independently near the pump to eliminate any strain on the pump casing. In addition, the piping should be aligned to avoid placing stress on the pump casing.
- The suction side of the pump should be as straight and short as possible to minimize pipe friction.
- The suction line should not have any high spots. This can create air pockets that can reduce pump performance. The suction piping should be level or slope slightly upward to the pump.
- The suction pipe should be 1 1/2" (38 mm). Larger suction piping will affect priming ability. Smaller piping affects NPSH available and pump performance.
- Provide for adequate suction submergence. Excessive submergence will reduce pump performance.
- The end of the pipe should be at least 3" (7.6 cm) above the bottom of the suction tank.
- If a strainer is used, it must be periodically cleaned to prevent restriction.
- It is recommended that a vacuum/pressure gage be installed in the suction piping.
- For faster priming on installations with high lift, a foot valve is recommended.
- Check and control valves (if used) should be installed on the discharge line. The control valve is used for regulating flow. Isolation valves on the suction and discharge are used to make the pump accessible for maintenance. The check valve helps protect the pump against damage from water hammer. This is particularly important when the static discharge head is high.

- **NOTE:** If a check valve is used in the discharge line, it must be placed at a distance at least equal to the maximum suction lift from the pump. If this cannot be done, an air vent must be provided in the discharge line.
- If flexible hose is preferred over pipe, use a reinforced hose rated for the proper temperature, pressure and is chemically resistant against the fluid being pumped.
- The suction valve must be completely open to avoid restricting the suction flow.
- When installing pumps with flanges, we recommend use of low seating stress gaskets such as Gore-Tex or Gylon (expanded PTFE).
- It is advisable to install a flush system in the piping to allow the pump to be flushed before the pump is removed from service.

NOTE: The pump is provided with a 1/2" BSP drain in the impeller housing.

- A "tee" can be installed in the discharge piping as an alternative location for filling the housing with fluid before pump operation.
- "Filling" is defined as filling the housing with 1 US gallon (3.8 liters) of liquid
- "Priming" is defined as evacuating all the air from the suction piping/pump and replacing it with fluid.

Motor/Electrical

Only qualified personnel trained in the safe installation and operation of this equipment should install the motor. Install the motor according to National Electric Code, NEMA MG-2, IEC standards requirements and/or applicable local electrical codes. The voltage and frequency variations of the power supply should never exceed the limits established in the applicable standard. Prior to connecting to the power line, check nameplate voltage, rotation connection and ensure proper grounding. Sufficient ventilation area should be provided to insure proper operation and cooling of the motor. The motor must be installed with a suitable overload protection circuit. For three phase motors it is recommended to install a phase failure protection device. Download the motor manual from the specific motor manufacturers' website for additional information concerning motor installation, safety and maintenance instructions.

Wire the motor for clockwise rotation when facing the fan end of the motor.

⚠ CAUTION: Do not operate the pump to check rotation until the pump is full of liquid or damage may occur even if the motor is "bumped" to check motor rotation direction.

Check all electrical connections with the wiring diagram on the motor. Make sure the voltage, frequency, phase and amp draw comply with the supply circuit.

If utilized, verify that power monitors or variable frequency drives have been properly installed according to the manufacturer's instructions.

To verify correct rotation of the motor:

1. Install the pump into the system.
2. Remove the fill plug (item 3A, 3 next to discharge) and fill the housing with 1 US gallon (3.8 liters) of the service liquid or water. Replace fill plug and tighten until the o-ring is seated.

NOTE: Use a funnel with flexible spout to fill the housing on pumps equipped with flanges.

3. Fully open the suction and discharge valves.
4. Jog the motor (allow it to run for 1-2 seconds) and observe the rotation of the motor fan. Refer to the directional arrow molded into the front of the housing if necessary.

NOTE: An SP pump running backwards may not prime.

Section III - Start-up and Operation

1. Be sure the housing (item 1) has been filled with 1 US gallon (3.8 liters) of service liquid and the fill plug (item 3A, 3) has been installed and tightened until the o-ring is seated.

2. Open the inlet (suction) and discharge valves completely.
3. Turn the pump on. Wait for discharge pressure and flow to stabilize (could take several minutes depending upon suction lift). Adjust the flow rate and pressure by regulating the discharge valve. Do not attempt to adjust the flow with the suction valve.

Section IV - Shutdown

- Turn off the motor.

NOTE: When the pump is stopped without a check valve in the piping, liquid will flow through the pump returning to the suction source. The SP design allows enough liquid to be retained in the housing to allow repriming without having to refill with liquid.

Flush Systems

⚠ CAUTION: Some fluids react with water; use compatible flushing fluid.

1. Turn off the pump.
2. Completely close the suction and discharge valves.
3. Connect flushing fluid supply to flush inlet valve.
4. Connect flushing fluid drain to flush drain valve.
5. Open flushing inlet and outlet valves. Flush system until the pump is clean.

NOTE: The drain can be used as the flushing drain valve using appropriate customer supplied fittings. Using the drain helps to promote superior flushing and draining results.

Maintenance

Recommended maintenance schedule

The recommended maintenance schedule depends upon the nature of the fluid being pumped and the specific application. If the pump is used on a clean fluid, it is recommended that the pump be removed from service and examined after six months of operation or after 2,000 hours of operation. If the pump is used on fluids with solids, high temperatures or other conditions that could cause accelerated wear this initial examination should be sooner.

After the initial examination of the internal components, and wear items are measured, a specific maintenance schedule can be determined. For best results, the pump should be removed from service annually for examination.

Section V - Disassembly

Tools Required: Metric socket or wrench set, 9/16" socket or wrench, 8 mm Allen wrench, and 3/16" Allen wrench (NEMA motors only), and pliers (for fill/drain plugs).

⚠ WARNING: Rotating Parts. This pump has components that rotate while in operation. Follow local safety standards for locking out the motor from the power supply during maintenance or service.

⚠ WARNING: Chemical Hazard. This pump is used for transferring many types of potentially dangerous chemicals. Always wear protective clothing, eye protection and follow standard safety procedures when handling corrosive or personally harmful materials. Proper procedures should be followed for draining and decontaminating the pump before disassembly and inspection of the pump. There may be small quantities of chemicals present during inspection.

⚠ WARNING: Magnetic force hazard. This pump should only be disassembled and assembled using the recommended procedures. The magnetic attraction is powerful enough to rapidly pull the motor end and the wet end together. Do not place fingers between the mating surfaces of the motor and wet ends to avoid injuries. Keep the drive magnet and impeller assembly away from metal chips or particles.

1. Stop the pump, lock out the motor starter, close all the valves that are connected to the pump, and drain/decontaminate the pump.

⚠ WARNING: The pump must be thoroughly flushed of any hazardous materials and all internal pressure relieved prior to opening the pump. Allow the pump to reach ambient temperatures prior to performing maintenance.

2. For pumps with motors 2 horsepower (1.5 kW) or smaller, securely clamp the pump feet to the bench. Remove the (4) bolts, lock washers and flat washers (items 22, 23, 24) securing the pump to the motor. See figure 9

Firmly grab the motor and pull straight back to disengage the motor and pump. See figure 11.



Figure 9



Figure 11



Figure 12



Figure 13

For pumps with motors 3 horsepower (2.2 kW) or larger, place the pump and motor on the floor. Remove the (4) bolts, lock washers and flat washers (items 22, 23, 24) securing the pump to the motor. Make sure the motor is on the fan end with the pump facing up. Pull straight up to remove the pump from the motor. See figure 12.

3. Place pump on bench with housing (item 1) facing up. Using an 8 mm hex (Allen) wrench, remove (8) 10 mm socket head cap screws, lock washers and flat washers (items 16, 17, 18). See figure 13.
4. Remove the housing by carefully inserting two flat head screwdrivers at the locations shown in figure 14. Slide the screwdrivers in at the bolt holes between the metal clamp ring (item 12B) and the housing until they stop. Applying equal pressure, gently pry both screwdrivers in an upward motion away from the work bench (to avoid damaging sealing surface on the housing). See figure 14A. Housing is tight due to o-ring seal on the internal “gooseneck.” NOTE: Do not twist the screwdrivers or damage may occur to the housing. Lift the housing straight up to remove.
5. Examine the housing for signs of wear or damage. Inspect “gooseneck” for cracks. See figure 15. Inspect suction and discharge for cracks. Inspect fill and drain plug o-rings (item 3A) for chemical attack, swelling, brittleness, cuts, etc.

Insert one (1) screwdriver under this bolting location. Insert approx. 7/8" until it hits the barrier.

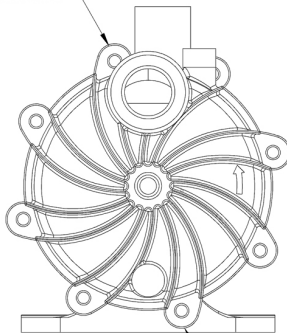

Figure 14

Insert one (1) screwdriver under this bolting location. Insert approx. 7/8" until it hits the barrier.

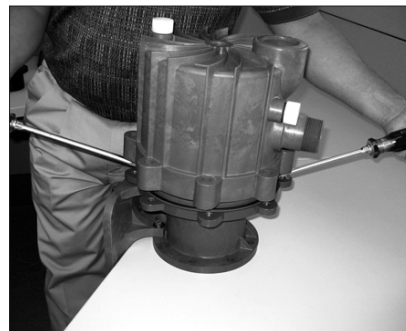

Figure 14A



Figure 15

6. Carefully remove the inner volute o-ring (item 5). See figure 16. Inspect for chemical attack, swelling, brittleness, cuts, etc.
7. Pull the separator plate (item 4) off the inner volute (item 6). See figure 17. Inspect for damage and cracks.
8. To remove the inner volute, pull back on the (3) snap fit prongs one at a time so that the hook portion falls into the

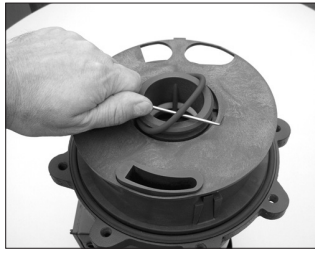

Figure 16

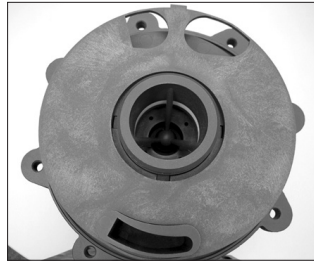

Figure 17

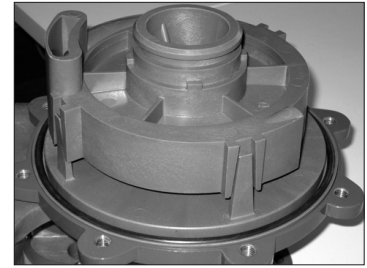

Figure 18

channel on the inner volute. See figure 18.

9. Pull the inner volute straight off. Be careful, the impeller shaft may come out with the inner volute. See figure 19. Inspect inner volute for signs of wear or damage. Look for signs of rubbing or cracking on the ring or damage to the front shaft support.
10. Remove impeller/inner drive assembly (items 7A, 7, 8, 8A). Inspect impeller and drive for signs of wear or damage. Look for signs of rubbing, damage and wear to the impeller and inner drive. See figure 20. Check the impeller thrust ring and bushing for wear. See figure 21.



Figure 19



Figure 20

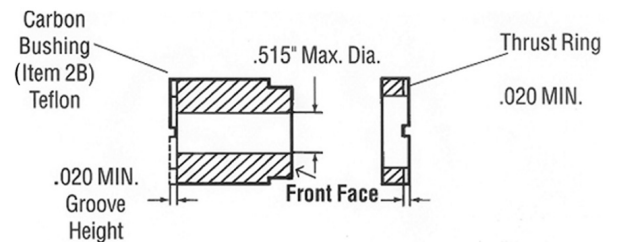

Figure 21

11. Remove the impeller shaft (item 9) from the barrier or inner volute and check for signs of cracking, chipping, scoring or wear. See figure 22.
12. Remove the barrier (item 11) from the motor adapter (item 12) (make sure the impeller shaft has been removed). Pull on one of the three prongs to remove the barrier. Note: Prongs are sharp. Use a glove or rag for better grip. Inspect the inside and outside of the barrier for signs of rubbing. See figure 23.
13. Remove the o-ring (item 10) from the barrier and inspect for chemical attack, swelling, brittleness, cuts, etc.
14. Visually inspect the outer drive (item 13) for rubbing, damage, corrosion or loose magnets.



Figure 22



Figure 23

Outer Drive Replacement

1. Remove the setscrews (item 13A) from the side of the drive (NEMA motors) or the bolt, lock washer and flat washer (items 19, 20, 21) from the center of the drive (metric motors).

⚠ WARNING: Be careful, tools will want to be attracted to the magnets.

2. Remove the drive magnet from the motor shaft by gently prying up from the bottom of the drive. See figure 24.
3. To reinstall the drive or a new drive follow the instructions from Section I - Assembly, Pumps without Motors, Steps 4-6.



Figure 24

Thrust Ring Replacement

1. Thrust ring (item 7A) is held in-place with a snap fit with a ridge. Using a razor knife or side cutters, cut a notch out of the thrust ring. Pull ring up and out of the holder. See figures 25 and 26.
2. To reinstall, align the two flats on the thrust ring with the flats in the bore of the impeller. Using a piece of wood press into place using an arbor press until the thrust ring is completely seated in the impeller.

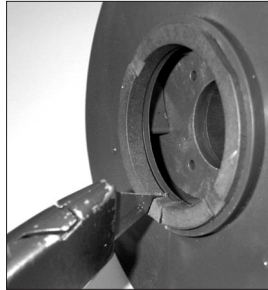

Figure 25

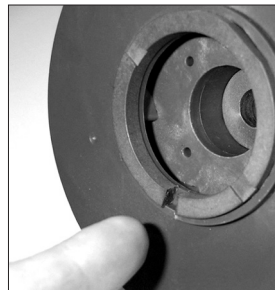

Figure 26

Bushing Replacement

1. To remove the bushing, place the impeller/inner drive assembly in an arbor press. Insert a 3/4" diameter plastic or wood shaft through the eye of the impeller and press the bushing out.
2. To replace the bushing (item 8A), place the top of the impeller on an arbor press with the thrust ring face down. Insert the front of the bushing (figure 27) into the center of the impeller/inner drive magnet assembly, aligning the flat on the bushing with the flat in the bore of the inner drive magnet. Using a soft arbor, press into place until the bushing reaches the shoulder molded into the inner drive (figures 28, 29).



Figure 27



Figure 28

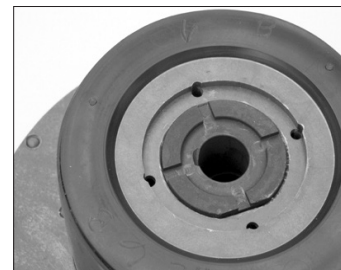

Figure 29

Impeller Replacement

⚠ CAUTION: Do no damage the outer surface of the inner drive magnet during impeller replacement.

Using the two slots provided, insert a flat blade screwdriver into them and pry the impeller (items 7A, 7) up from the body of the inner drive magnet (items 8, 8A). Once a gap has been established, work around the perimeter to evenly increase the gap until the impeller can be removed. See figure 30.

To install a new impeller, place the inner drive magnet assembly face up (splines facing up) on an arbor press. Align the spines in the impeller with the ones in the bore on the inner drive magnet. Place a piece of wood over the top of the impeller thrust ring. Using an arbor press, push down on the impeller until it is completely seated in the inner drive.



Figure 30

Section VI - Clamp Ring Replacement and Reassembly

1. Inspect the clamp ring. If clamp ring requires replacement, it is recommended to remove the plastic foot (item 15) first. NOTE: 100/112 frame B5 adapters do not use the foot. See figures 32 and 33. Remove the four (4) M6 bolts (items 28 and 28A).

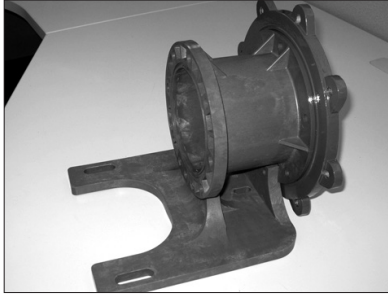

Figure 32

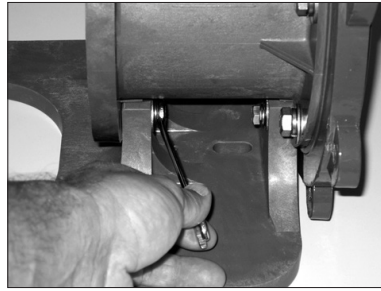

Figure 33

2. Remove the five (5) M8 bolts, lock washers and flat washers (items 34, 33, and 32) from the clamp ring (item 12B). See figure 34. Remove the clamp ring from the motor adapter. There is a snug fit between the clamp ring and motor adapter due to the vapor protection o-ring (item 12C). Carefully pull the two parts apart. See figure 35.

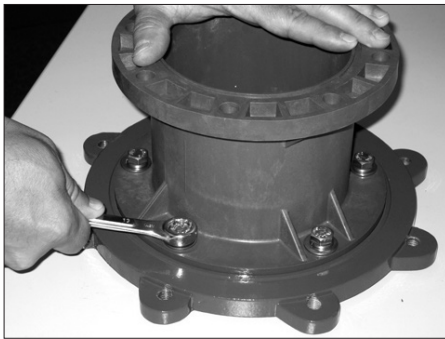

Figure 34



Figure 35

3. Inspect the motor adapter o-ring (item 12C). Replace if damaged. If it is reusable, lubricate it with a chemically compatible lubricant. See figure 36.
4. Install the new clamp ring. Place the clamp ring on a flat surface. See figure 37. Align the bolt holes (five motor adapter and two foot bolt holes) on the clamp ring with the bolt holes on the motor adapter. Push the motor adapter straight down onto the clamp ring to seat the o-ring. See figure 38. Install five M8 bolts, lock washers and flat washers (items 34, 33 and 32) and tighten in a star pattern to 130 in-lbs. (14.7 N-m). See figure 39.



Figure 36

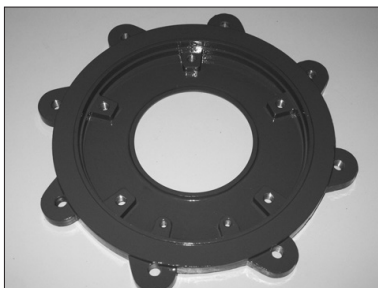

Figure 37



Figure 38



Figure 39

- For 56C, 145TC and 80 frame B14, re-install the plastic foot (item 15) to the motor adapter (item 12D). Use the longer M6 bolts, lock washers and flat washers (items 28A, 29 and 30) for the front bolt holes towards the clamp ring. See figure 40. Use the shorter M6 bolts, lock washers and flat washers (items 28, 29 and 30) for the rear bolt holes towards the motor face. NOTE: Nuts (item 31) are glued into the rear of the motor adapter to help with the installation of the rear bolts. Make sure the nuts are still in place. See figure 41. Tighten bolts to 5 ft-lbs. (6.8 N-m). For 184 frame, IEC 90, 100/112 frame B14 and 80/90 frame B5, leave the foot off until the motor adapter is installed on the motor. This will allow easier access to the bottom bolt hole in the motor adapter.

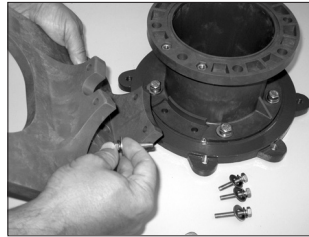

Figure 40



Figure 41

- Position the motor adapter assembly on a flat surface. If the foot is installed, allow the feet to hang over the edge. see figure 42. Install the o-ring (item 12A) into the groove on the clamp ring. Lubricate the o-ring with a compatible lubricant. See figure 43.

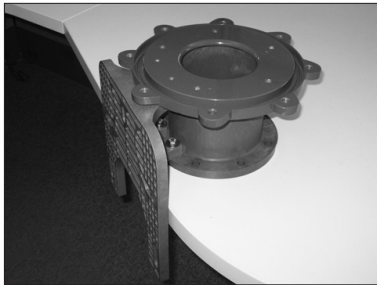

Figure 42



Figure 43

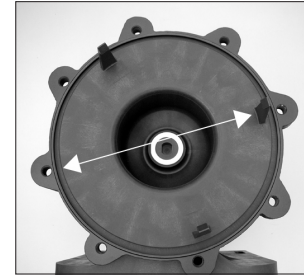

Figure 43A

- Install the barrier (item 11) into the clamp ring (item 12B). Line up the prong that has no prong opposite it with the 2 o'clock housing bolt hole in the clamp ring. See figure 43A. NOTE: Leave the barrier loose in the clamp until installing the housing (item 1) to make sure the bolt holes line up.
- Install o-ring (item 10) in groove in barrier. Make sure it is tucked in all the way around. See figure 44.
- Install impeller shaft (item 9) into barrier by aligning the flats on the shaft with the ones in the barrier. Make sure it is completely seated. See figure 44
- Carefully install the impeller/inner drive assembly (items 7A, 7, 8, 8A) by sliding it over the impeller shaft in the barrier. It is normal for the impeller/inner drive to pop up a slight amount due to magnetic forces. See figures 45 and 46.

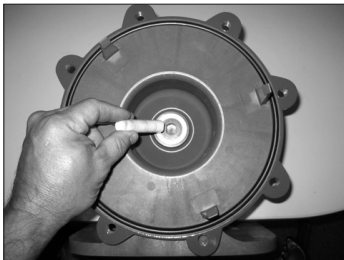

Figure 44

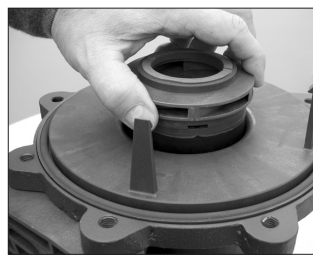

Figure 45

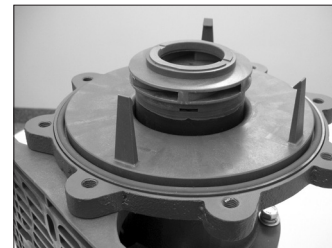

Figure 46

- Install the inner volute (item 6) by lining up the prongs of the barrier with the channels in the inner volute. Press down evenly until the prongs snap onto the surface of the inner volute. See figures 47 and 48.

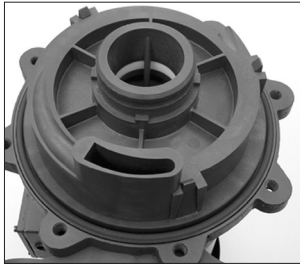

Figure 47

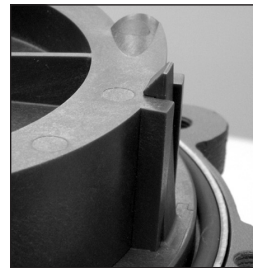

Figure 48

12. Install the separator plate (item 4) by lining up the bottom opening of the inner volute with the opening in the plate. Line up the slots in the separator plate with the notches in the inner volute. See figure 49.
13. Lubricate the inner volute o-ring (item 5) with a chemically compatible lubricant and install in the groove on the round suction nozzle in the center of the inner volute. See figure 50.

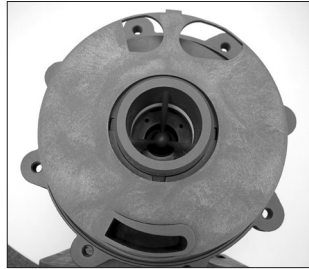

Figure 49



Figure 50

14. Lubricate the inside of the gooseneck. See figure 51. Install the housing (item 1). Line up the tab on the top of the separator plate with the notch in the housing (located inside the front of the housing near the discharge port). See Figure 51. Using uniform pressure, press the housing and barrier into place until it is flush with the motor adapter. See figure 52.

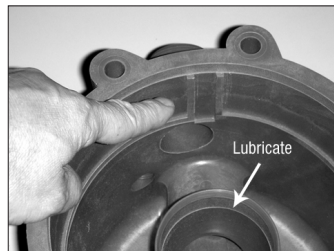

Figure 51



Figure 52

Note: The fit is tight due to inner volute o-ring. Make sure o-ring is lubricated.

Install the housing bolts, lock washers and flat washers (items 16, 17, 18). Tighten all bolts evenly using a star pattern. Tighten to 20 foot-lbs (27 N-m).

15. Reinstall the pump on the motor/drive magnet following instructions found in “Assembly, Pumps without Motors,” steps 7-10.

SP11 / SP15 PART NUMBER EXPLANATION

NOTE: Pump end includes wetted components, drive magnet and motor adapter. The wet end includes wetted components only.

Part Number Explanation

The base model number contains standard components. Where standard components are not suitable, add the alternative component code after the base model number to substitute components. Example: SP11-E-U-14 is constructed of the listed base model components except it has an EPDM o-ring, union connections, and a 145TC motor adapter.

The model number is on the serial number label located on the motor adapter. The model number contains a base model that features certain standard components.

Compare the model number on the pump to the adjacent chart to determine if the pump contains any alternate components. Model numbers containing "P" have primary components molded from polypropylene. Model numbers containing "V" have primary components molded from PVDF.

Base model numbers are: SP11P, SP11V.

BASE MODEL COMPONENTS		ALTERNATIVE COMPONENTS (MAY BE ADDITIONAL COST)								Code
Bushing	Graphite Carbon	PTFE								T
		Alumina Ceramic								R
O-Ring	FKM	EPDM								E
		Simriz								S
		Kalrez								K
Connection	NPT	BSP Threads								B
		Union								U
		Steel Reinforced Flange - ANSI 150 / PN20/40 / JIS 10K								Fs
		FRP Flange - ANSI 150 / PN20/40 / JIS 10K								Ff
Impeller	1 (Max size 60 Hz)	Select impeller								
		2	3	4	5	6	7	8	9	10
Magnet	SP11: 6-Pole SP15: 8-Pole (Upgrade or down-grade for specific gravity corrections)	6-Pole: up to 2 hp (1.5 kW) 56C/145/80/90 frames								6p
		8-Pole: up to up to 3 hp (2.2 kW) 56C/145TC/80/90 frames								8p
		10-Pole: up to 5 hp (4 kW) 184TC/100/112 and gas engine frames								10p
Motor Adapter	56C NEMA	143/145TC NEMA								14
		182/184TC NEMA								18
		IEC 63/B14								64
		IEC 71/B14								74
		IEC 80/B14								84
		IEC 90/B14								94
		IEC 100/B14								04
		IEC 112/B14								24
		IEC 63/B5								65
		IEC 71/B5								75
		IEC 80/B5								85
		IEC 90/B5								95
		IEC 100/B5								05
		IEC 112/B5								25
		Gas engine mounting								GE
		Specials		SiC bushing, thrust ring, shaft						
Hastelloy shaft								Hs		
Titanium hardware								Ti		
Non-sparking ring								Ns		
316SS clamp ring								Sr		
Motor	Not Standard	Contact dealer or factory for motor details								

SP11/15 Parts Diagram

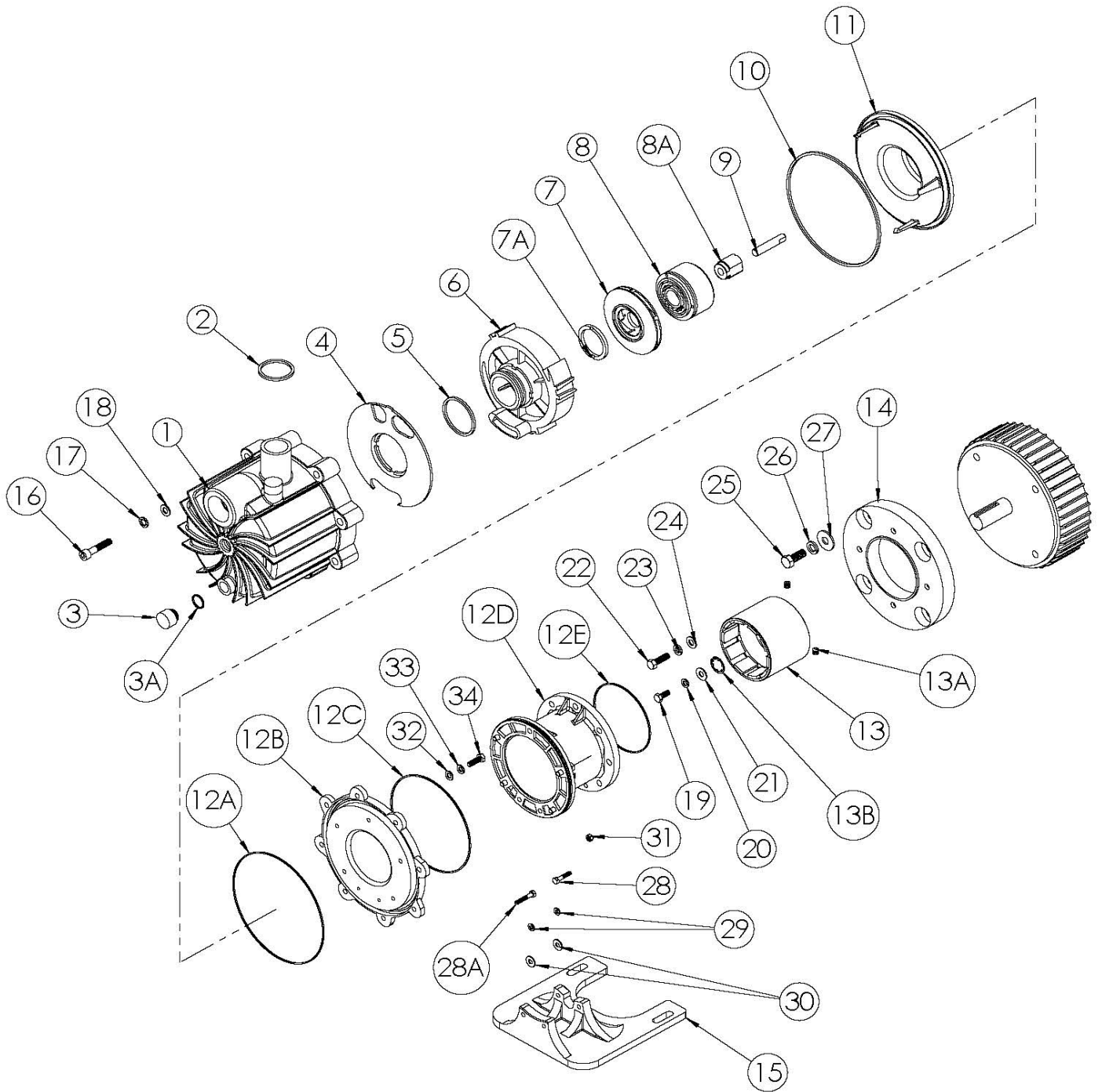

SP11/SP15 Spare Parts List

Item	Qty	Description	SP11		SP15	
			Pump Material		Pump Material	
			PP	PVDF	PP	PVDF
1	1	Housing				
		NPT threads	105862	105862-1	105862	105862-1
		BSP threads	105862-2	105862-3	105862-2	105862-3
		Steel flanges - ANSI150/PN20/40/JIS10K	105866	105866-2	105866	105866-2
		FRP flanges - ANSI150/PN20/40/JIS10K	105866-1	105866-3	105866-1	105866-3
		Unions	105867	105867-1	105867	105867-1
2	1	Discharge O-Ring (BSP Threaded Housings Only)				
		EPDM			105918	
		FKM			105919	
3	2	Fill/Drain Plug				
			106143	106143-1	106143	106143-1
3A	2	Fill Plug O-Ring				
		EPDM			106154	
		FKM			106155	
4	1	Separator Plate				
			105863	105863-1	105863	105863-1
5	1	Inner Volute O-Ring				
		EPDM			J103478	
		FKM			J103477	
6	1	Inner Volute (Select For Appropriate Impeller Diameter)				
		#1 impeller (4.63"/SP11, 5.13"/SP15) w/ ceramic ring	105864-2	105864-3	105865-2	105865-3
		#2 impeller (4.38"/SP11, 5.00"/SP15) w/ ceramic ring	105864-4	105864-5	105865-4	105865-5
		#3 impeller (4.13"/SP11, 4.75"/SP15) w/ ceramic ring	105864-6	105864-7	105865-6	105865-7
		#4 impeller (3.88"/SP11, 4.50"/SP15) w/ ceramic ring	105864-8	105864-9	105865-8	105865-9
		#5 impeller (3.63"/SP11, 4.25"/SP15) w/ ceramic ring	105864	105864-1	105865	105865-1
		#6 impeller (5.25"/SP11, 5.50"/SP15) w/ ceramic ring	105864-10	105864-11	105865-10	105865-11
		#7 impeller (5.00"/SP11, 5.25"/SP15) w/ ceramic ring	105864-12	105864-13	105865-12	105865-13
		#8 impeller (4.75"/SP11, 5.00"/SP15) w/ ceramic ring	105864-14	105864-15	105865-4	105865-5
		#9 impeller (4.00"/SP11) w/ ceramic ring	105864-16	105864-17	N/A	N/A
		#10 impeller (4.25"/SP11) w/ ceramic ring	105864-18	105864-19	N/A	N/A
		#1 impeller (4.63"/SP11, 5.13"/SP15) w/ SiC ring	105909-2	105909-3	105910-2	105910-3
		#2 impeller (4.38"/SP11, 5.00"/SP15) w/ SiC ring	105909-4	105909-5	105910-4	105910-5
		#3 impeller (4.13"/SP11, 4.75"/SP15) w/ SiC ring	105909-6	105909-7	105910-6	105910-7
		#4 impeller (3.88"/SP11, 4.50"/SP15) w/ SiC ring	105909-8	105909-9	105910-8	105910-9
		#5 impeller (3.63"/SP11, 4.25"/SP15) w/ SiC ring	105909	105909-1	105910	105910-1
		#6 impeller (5.25"/SP11, 5.50"/SP15) w/ SiC ring	105909-10	105909-11	105910-10	105910-11
		#7 impeller (5.00"/SP11, 5.25"/SP15) w/ SiC ring	105909-12	1015909-13	105910-12	105910-13
		#8 impeller (4.75"/SP11, 5.00"/SP15) w/ SiC ring	105909-14	105909-15	105910-4	105910-5
		#9 impeller (4.00"/SP11) w/ SiC ring	105909-16	105909-17	N/A	N/A
#10 impeller (4.25"/SP11) w/ SiC ring	105909-18	105909-18	N/A	N/A		
7	1	Impeller Assembly (Select Appropriate Impeller Diameter)				
		<i>See SP11/15 Impeller Assemblies Table</i>				
7A	1	Impeller Thrust Ring Only				
		Filled PTFE			105694-1	
		Silicon carbide			105694-3	

Item	Qty	Description	SP11		SP15	
			Pump Material		Pump Material	
			PP	PVDF	PP	PVDF
8	1	Impeller Drive Assembly				
		6-Pole with carbon bushing	105913	105913-3	105913	105913-3
		8-Pole with carbon bushing	105913-1	105913-4	105913-1	105913-4
		10-Pole with carbon bushing	105913-2	105913-5	105913-2	105913-5
		6-Pole with PTFE bushing	105913-6	105913-9	105913-6	105913-9
		8-Pole with PTFE bushing	105913-7	105913-10	105913-7	105913-10
		10-Pole with PTFE bushing	105913-8	105913-11	105913-8	105913-11
		6-Pole with alumina ceramic bushing	105913-12	105913-15	105913-12	105913-15
		8-Pole with alumina ceramic bushing	105913-13	105913-16	105913-13	105913-16
		10-Pole with alumina ceramic bushing	105913-14	105913-17	105913-14	105913-17
		6-Pole with silicon carbide bushing	105913-18	105913-21	105913-18	105913-21
		8-Pole with silicon carbide bushing	105913-19	105913-22	105913-19	105913-22
10-Pole with silicon carbide bushing	105913-20	105913-23	105913-20	105913-23		
8A	1	Impeller Bushing Only				
		Carbon			J100977	
		Filled PTFE			106386	
		Alumina ceramic			106386-2	
		Silicon carbide			106386-1	
9	1	Impeller Shaft				
		Alumina ceramic			105811-1	
		Silicon carbide			105811-2	
		Hastelloy C			105811-3	
10	1	Housing O-Ring				
		EPDM			105717	
		FKM			105716	
11	1	Barrier				
			105689-3	105689-4	105689-3	105689-4
12	1	Motor Adapter Kit (includes items 12A-12E plus hardware)				
		Standard motor adapter - all frame sizes	107405	107406	107405	107406
		Standard motor adapter with non-sparking ring - all frame sizes	107407	107408	107407	107408
		<i>Note: 182/184TC & all IEC frames MAY need to order motor adapter flange (item 14) and hardware (items 22-24 & 25-27)</i>				
12A	1	Barrier/Clamp Ring O-ring				
		Buna			107281	
		FKM			107279	
		EPDM			107280	
12B	1	Clamp Ring				
		Painted cast iron (Standard)	107228	107228-1	107228	107228-1
		Painted cast iron with non-sparking ring	107321	107321-1	107321	107321-1
		Stainless steel	108600	108600	108600	108600
		Stainless steel with non-sparking ring	108600-1	108600-1	108600-1	108600-1
12C	1	Clamp Ring/Motor Adapter Column O-ring				
		Buna			107282	
		FKM			107283	
		EPDM			107284	
12D	1	Motor Adapter Column				
		Standard	106890	106890-1	106890	106890-1

Item	Qty	Description	SP11		SP15	
			Pump Material		Pump Material	
			PP	PVDF	PP	PVDF
12E	1	Motor Adapter column to motor o-ring (NEMA 56C/145TC motors only)				
		Buna			106549	
		FKM			106374	
		EPDM			106373	
13	1	Drive Magnet Assy				
		6-Pole 56C frame - includes set screws and snap ring			105878	
		8-Pole 56C frame - includes set screws and snap ring			105878-1	
		6-Pole 143/145TC frame - includes set screws and snap ring			105878-3	
		8-Pole 143/145TC frame - includes set screws and snap ring			105878-4	
		10-Pole 182/184TC frame - includes set screws and snap ring			105730-9	
		6-Pole 80 frame - includes snap ring			105882	
		8-Pole 80 frame - includes snap ring			105882-1	
		6-Pole 90 frame - includes snap ring			105882-3	
		8-Pole 90 frame - includes snap ring			105882-4	
		10-Pole 100/112 frame- includes snap ring			105730-18	
13A	2	Set Screws- NEMA Motors Only				
					J101084	
13B	1	Snap Ring				
		56C frame			105708	
		143/145TC frame			105709	
		182/184TC frame			105710	
		80 frame			105711	
		90 frame			105712	
		100/112 frame			105710	
14	1	Motor Adapter Flange				
		182/184TC frame	105751-1	105751-2	105751-1	105751-2
		80 frame with B14 flange	105724-1	105724-2	105724-1	105724-2
		90 frame with B14 flange	105725-1	105725-2	105725-1	105725-2
		100/112 frame with B14 flange	105726-1	105726-2	105726-1	105726-2
		80/90 frame with B5 flange	106274	106274-1	106274	106274-1
		100/112 frame with B5 flange	107315	107315-1	107315	107315-1
15	1	Foot (100/112 frame pumps with B5 flange do not include a pump foot)				
		All frames sizes except 100/112	105691-1	105691-4	105691-1	105691-4
		100 frame with B14 flange	105691-3	105691-6	105691-3	105691-6
		112 frame with B14 flange	105691-2	105691-5	105691-2	105691-5

Hardware - All SP11/15 Models

Item	Qty	Description	Stainless Steel	Titanium
16	8	Housing bolt		
			106210	106211
17	8	Housing Lock Washer		
			105757	105758
18	8	Housing Flat Washer		
			105722	105773
19	1	Drive Bolt- IEC Motors Only		
		80 frame IEC	105765	105766
		90 frame IEC	105770	105771
		100/112 frame IEC	105774	105775
20	1	Drive Lockwasher (IEC frames only)		
		80 frame IEC	J100672	J104203
		90 frame IEC	J102282	J103847
		100/112 frame IEC	J100115	J104206
21	1	Drive Flatwasher (IEC frames only)		
		80 frame IEC	105767	105768
		90 frame IEC	105722	105773
		100/112 frame IEC	J101360	106200
22	4	Motor Adapter Bolts		
		All frames except 100/112 B5	J103118	105752
		100/112 B5 frames only	J100114	106311
23	4	Motor Adapter Lockwasher		
			J100115	J104206
24	4	Motor Adapter Flatwasher		
			J100128	J104207
25*	4	Motor Adapter Flange Bolts		
		182/184 Frame	J103782	105761
		80 Frame B14 IEC	105765	105764
		90 Frame B14 IEC	105770	105771
		100/112 Frame B14 IEC	105770	105771
26*	4	Lockwasher- Motor Adapter Flange		
		182/184 Frame	J101023	105762
		80 Frame B14 IEC	J100672	J104203
		90 Frame B14 IEC	J102282	J103847
		100/112 Frame B14 IEC	J102282	J103847
27*	4	Flatwasher- Motor Adapter Flange		
		182/184 Frame	J103851	105763
		80 Frame B14 IEC	J100113	J104204
		90 Frame B14 IEC	J101293	J103845
		100/112 Frame B14 IEC	J101293	J103845
28	2	Rear Foot Bolt		
			J103968	107288
28A	2	Front Foot Bolt		
			107289	107290
29	4	Foot Lockwasher		
			J100672	J104203
30	4	Foot Flatwasher		
			J100113	J104204
31	2	Nut- Rear Foot Bolt		
			107286	107287
32	5	Clamp Ring Flatwasher		
			J101293	105768

Hardware - cont.

Item	Qty	Description	Stainless Steel	Titanium
33	5	Clamp Ring Lockwasher		
			J102282	J103847
34	5	Clamp Ring Bolt		
			J103662	107285

*For IEC B5 frame pumps: Hardware is to be supplied by customer due to variations in B5 frame motors.

SP11/15 Impeller Assemblies

	Thrust Ring	Impeller Material	#1	#2	#3	#4	#5	#6	#7	#8	#9	#10
						4.63"	4.38"	4.13"	3.88"	3.63"	5.25"	5.00"
SP11	PTFE	Polypro	105911	105911-4	105911-6	105911-8	105911-10	105911-2	105911-14	105911-16	105911-18	105911-20
		PVDF	105911-1	105911-5	105911-7	105911-9	105911-11	105911-3	105911-15	105911-17	105911-19	105911-21
	SiC	Polypro	105915	105915-4	105915-6	105915-8	105915-10	105915-2	105915-14	105915-16	105915-18	105915-20
		PVDF	105911-1	105915-5	105915-7	105915-9	105915-11	105915-3	105915-15	105915-17	105915-19	105915-21
SP15	Thrust Ring	Impeller Material	#1	#2	#3	#4	#5	#6	#7	#8	-	-
			5.13"	5.00"	4.75"	4.50"	4.25"	5.50"	5.25"	5.00"	-	-
	PTFE	Polypro	105911-12	105916	105916-4	105916-6	105916-8	105916-10	105916-12	105916-14	-	-
		PVDF	105911-13	105916-2	105916-5	106916-7	105916-9	105916-1	105916-13	105916-15	-	-
	SiC	Polypro	105915-12	105917	105917-4	105917-6	105917-8	105917-10	105917-12	105917-14	-	-
		PVDF	105915-13	105917-2	105917-5	106917-7	105917-9	105917-1	105917-13	105917-15	-	-

Section VII - Troubleshooting

General Notes:

- Cold water can contain dissolved air. Under high lift applications, the air can come out of solution blocking suction passages. This can lead to lack of priming, slow priming or low flow rates.

Do not pump liquids containing ferrous metal fines.

- If magnets de-couple, stop pump immediately. Operating the pump with the magnets de-coupled will eventually weaken the magnets.
- Do not use mismatched drive magnet assemblies (different number of magnets on inner and outer drive magnet assemblies).
- Contact our Technical Service Department at 1-800-888-3743 or by e-mail at techservice@finishthompson.com if you have any questions regarding product operation or repair.

No or Insufficient Discharge

- Air leaks in suction piping
- Housing not filled with priming fluid
- Suction pipe smaller than 1 1/2"
- Suction pipe contains high spots causing trapped air pockets
- Suction pipe excessively long (flow drops as suction pipe gets longer)
- System head higher than anticipated
- Closed valve
- Viscosity or specific gravity too high
- Motor too large for magnet coupling rating (magnets uncoupled)
- Suction lift too high or insufficient NPSH
- Clogged suction line, suction strainer (if used) or impeller vanes

Insufficient Pressure

- Air or gas entrained liquid
- Impeller diameter too small
- System head lower than anticipated
- Motors speed insufficient (too low) or motor rotation incorrect (correct rotation when viewed from the fan end is clockwise)

Won't Prime

- Did not fill housing with fluid before initially starting pump
- Closed discharge valve (valve should be open or open air vent line)
- Leak in suction piping
- Suction pipe not submerged enough (causing a vortex or exposing the end of the suction pipe)
- Lift exceeds pump ability (see SP11/15 Capabilities section)
- Suction pipe diameter too large
- Specific gravity or local atmospheric pressure (altitude/elevation) not accounted for in lift calculations
- Mismatch of inner volute and impeller diameter
- Inner volute o-ring chemically attacked, cut, brittle, etc.
- Motor rotation incorrect (correct rotation when viewed from the fan end is clockwise)
- Check valve installed too close to the pump

Primes Slowly

- Mismatch of inner volute and impeller diameter
- Suction pipe diameter too large (larger than 1 1/2")
- Closed discharge valve (valve should be open)
- Inner volute o-ring chemically attacked, cut, brittle, etc.

Excessive Power Consumption

- Head lower than rating
- Excessive flow
- Specific gravity or viscosity too high.

Vibration/Noise

- Loose magnet
- Drive magnet rubbing
- Pump cavitating from improper suction or feed
- Motor or piping not properly secured
- Foreign object in impeller

Section VIII - Warranty

Finish Thompson, Inc (manufacturer) warrants this pump product to be free of defects in materials and workmanship for a period of five years from date of purchase by original purchaser. If a warranted defect, which is determined by manufacturer's inspection, occurs within this period, it will be repaired or replaced at the manufacturer's option, provided (1) the product is submitted with proof of purchase date and (2) transportation charges are prepaid to the manufacturer. Liability under this warranty is expressly limited to repairing or replacing the product or parts thereof and is in lieu of any other warranties, either expressed or implied. This warranty does not apply to normal wear of the product or components. This warranty does not apply to products or parts broken due to, in whole or in part, accident, overload, abuse, chemical attack, tampering, or alteration. The warranty does not apply to any other equipment used or purchased in combination with this product. The manufacturer accepts no responsibility for product damage or personal injuries sustained when the product is modified in any way. If this warranty does not apply, the purchaser shall bear all cost for labor, material and transportation.

Manufacturer shall not be liable for incidental or consequential damages including, but not limited to process down time, transportation costs, costs associated with replacement or substitution products, labor costs, product installation or removal costs, or loss of profit. In any and all events, manufacturer's liability shall not exceed the purchase price of the product and/or accessories.

Warranty Registration

Thank you for your purchase of this quality Finish Thompson product. Be sure to take a minute to register your pump at Finishthompson.com/warranty. Simply provide the model number, serial number and a few other pieces of information.

Ordering Spare Parts

Spare parts can be ordered from your local distributor. Always refer to the pump model to avoid error.



FINISH THOMPSON INC.

921 Greengarden Road • Erie, PA 16501-1591 U.S.A.
Ph 814-455-4478 • Fax 814-455-8518
Email fti@finishthompson.com • www.finishthompson.com

Part Number 107404, Rev18, 4/20/2020
Order fax: 814-459-3460
Tech Service: 800-888-3743

